



LHS₂-SERIES
LINEAR ARM FIXTURE

TABLE OF CONTENTS

| | |
|-----------|------------------------------------|
| 3 | Specialist fixture solutions |
| 3 | Fixture assembly |
| 4 | Innovative lever mechanism |
| 5 | Linear arm fixture |
| 7 | Available housing types |
| 8 | Linear arm fixture exchange system |
| 9 | Available housing types |
| 10 | Accessories for the LHS2-series |
| 10 | Fixture configurator |

Imprint

Publisher:

ATX Hardware GmbH West

Am Kornfeld 8

86932 Pürgen

Germany

Phone +49 8196 9304-0

Telefax + 49 8196 9304-19

E-Mail: projekte@atx-hardware.de

Website: www.atx-hardware.de

SPECIALIST FIXTURE SOLUTIONS

ATX is Europe's market leader in the manufacture of test fixtures for electronic test procedures.

Why you too should choose an ATX fixture - it's simple:

TECHNICAL KNOW-HOW

Our sales team is technically well versed - our consultants are selected from the design team or other technical departments.

PROJECT KNOW-HOW

We work together with you towards a common goal: to find and implement the optimal solution for your individual testing requirements.

KNOWLEDGE BASE

Our employees bring well over 1,000 man-years of fixture building experience to the team.

SINCE 1997

FIXTURE ASSEMBLY

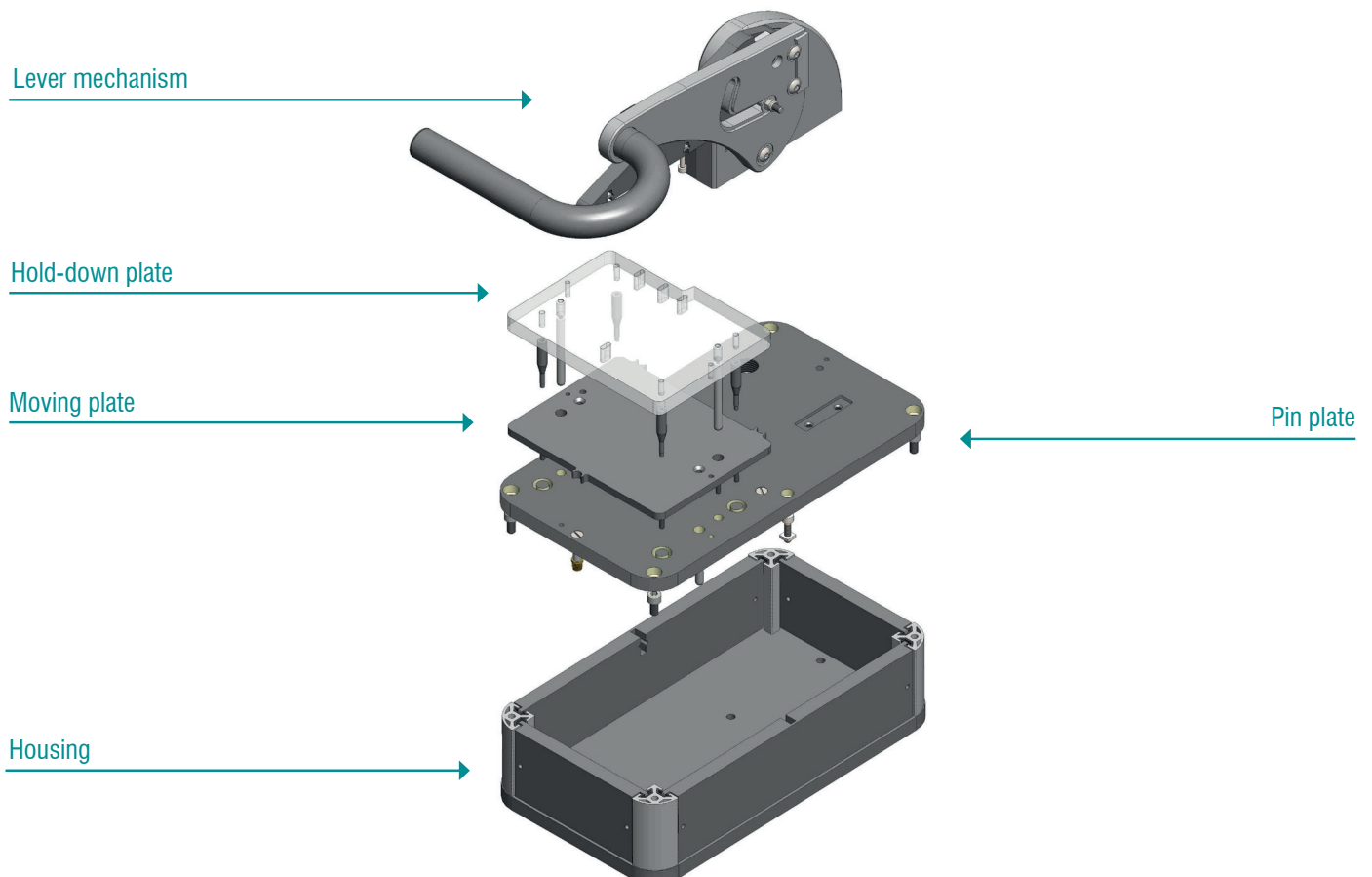

INNOVATIVE LEVER MECHANISM



HIGHLIGHTS

- Ideal for selective indications
- Individually customizable
- Effortless operation
- For adaption on both sides
- In 3 versions

THE LINEAR ARM FIXTURE

Radial and linear stroke

The special feature of our LHS2 is not only the compact, efficient and cost-effective variant in fixture construction, but also quite clearly the radial and simultaneously linear stroke. This also explains the name for our **linear arm fixture**.

With this design, the placed hold-downs are pressed evenly linearly onto the assembly with the arm transmission and thus contact the needles. The main advantage here is that the spring contact pins are pressed absolutely vertically and precisely. The centering of the hold-down plate also offers an optimized hold-down option, even for tightly assembled assemblies. The generous opening angle enables uncomplicated handling during insertion and removal

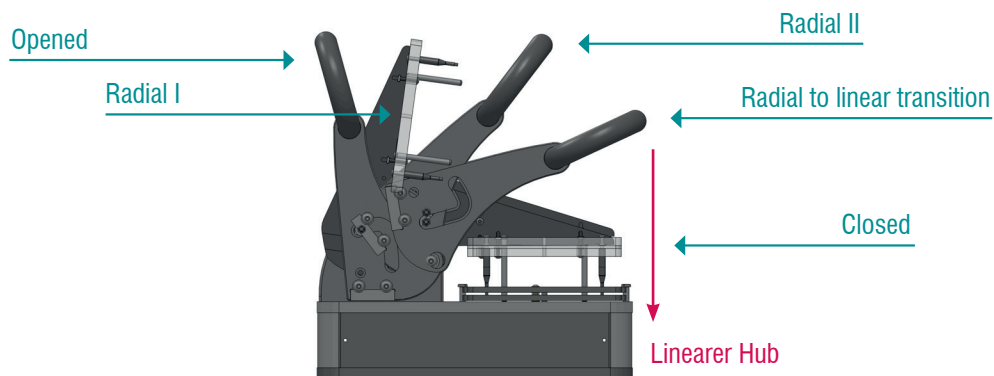

LINEAR ARM FIXTURE



LHS2 - LINEAR ARM FIXTURE

Simply contact more efficiently

If your company's testing and checking involves small series, programming or laboratory tasks, you can solve these even more efficiently with the LHS2. Also if you want to equip your functional test stations innovatively for future tasks and open up new dimensions for your functional tests. With the LHS2 linear arm fixture from ATX, you have the perfectly suitable device with many convincing advantages.

And if required for your specific application, it also works on both sides. The LHS2 from ATX is not only small, extra compact and absolutely uncomplicated to operate. It also helps you to handle upcoming inspection tasks quickly and economically. And because you are getting a mechanical lever device „Made in Germany“ in your test environment, you are assured of the highest quality, outstanding product substance and long service life.

But that's not all: Since our linear arm fixture represents the proven entry-level class in mechanical inspection and testing that has been technically tested over many years, we can provide you with a maximum technical and economic solution.

- Anytime from stock as standard kit, if you want to dismantle your device yourself
- Or as a completely customized ready-to-use adapter - exclusively adapted to your specific requirements

STANDALONE FIXTURE LEGEND

Linear arm fixture

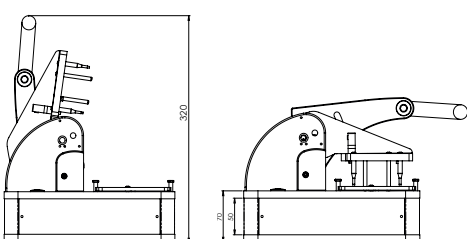

LHS2-Standard height 50mm

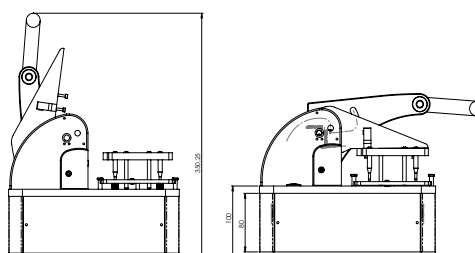

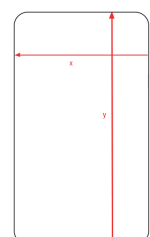

LHS2-Special height 80mm



Moving plate dimension X x Y

LINEAR ARM FIXTURE

STANDALONE - IN 3 COMPACT SIZES

| Designation | Fixture | Moving plate (x x y) | Pressure force | Order number |
|-------------|---|----------------------|----------------|--------------|
| LHS2-A |  | 85 x 85 | 100 N | 100707 |
| LHS2-D |  | 125 x 125 | 200 N | 100828 |
| LHS2-F |  | 200 x 130 | 200 N | 100961 |

STANDALONE - WITH SPECIAL HEIGHT 80 MM

| Designation | Fixture | Moving plate (x x y) | Pressure force | Order number |
|-------------|---|----------------------|----------------|--------------|
| LHS2-A-High |  | 85 x 85 | 100 N | 100241 |
| LHS2-D-High |  | 125 x 125 | 200 N | 100338 |
| LHS2-F-High |  | 200 x 130 | 200 N | 100341 |

AVAILABLE HOUSING TYPES

FOR LHS2 TO FIT FLEXIBLY INTO YOUR TEST ENVIRONMENT

Housing with back panel (connectors can be mounted as required)

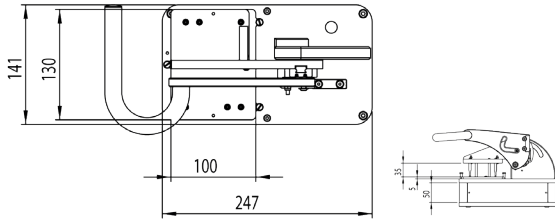

100707

Standard housing for LHS2-A

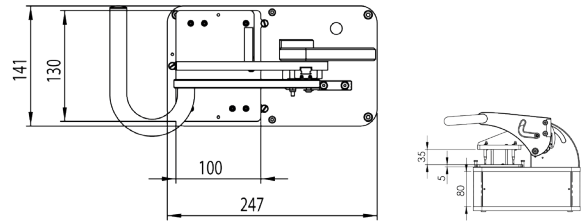

100241

Standard housing for LHS2-A-High

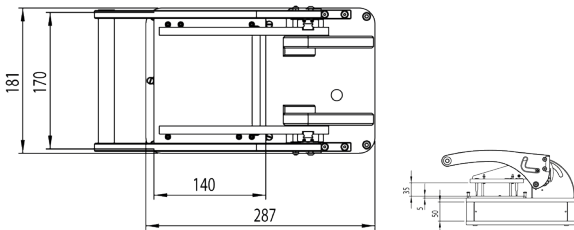

100828

Standard housing for LHS2-D

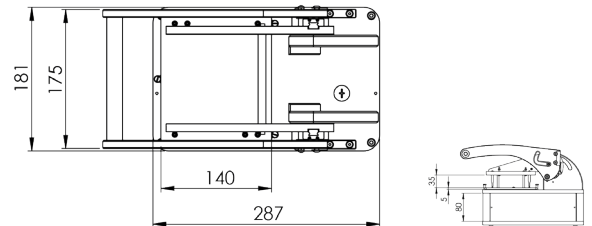

100338

Standard housing for LHS2-D-High

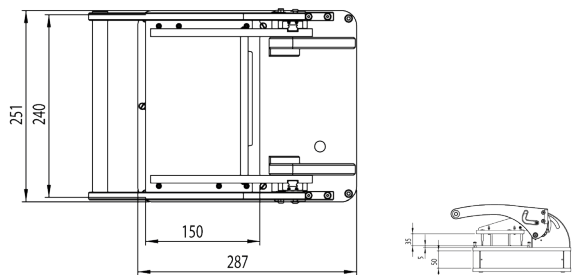

100961

Standard housing for LHS2-F

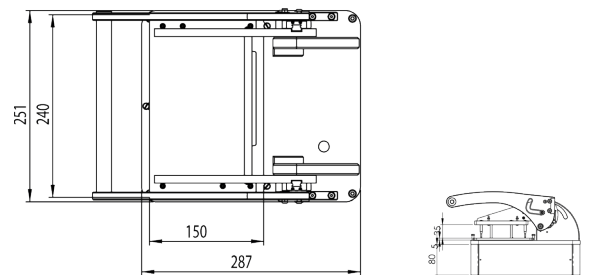

100341

Standard housing for LHS2-F-High

LINEAR ARM FIXTURE EXCHANGE SYSTEM

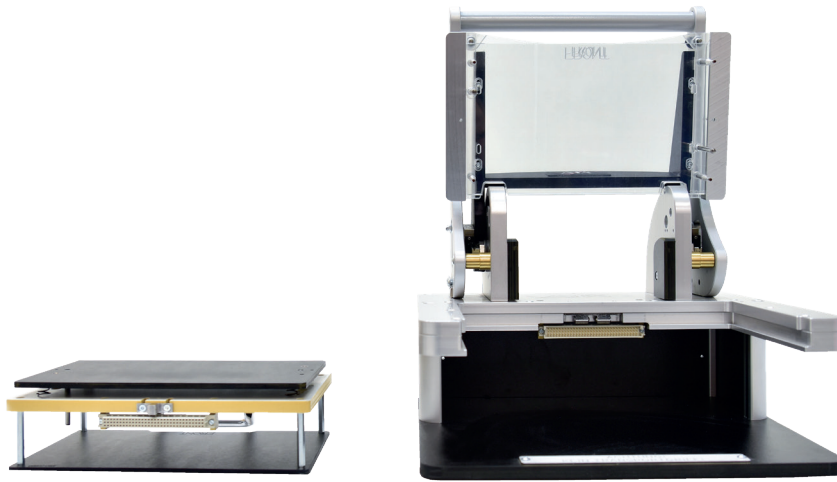

LHS2W - LINEAR ARM FIXTURE EXCHANGE SYSTEM

Offers you even more flexibility

Do you frequently change products to be tested at short intervals? Then you should opt for the LHS2W model variant with exchange system. This allows the necessary product changeovers to be carried out quickly and safely without tools, while the wear-resistant interface guarantees minimum maintenance and the shortest possible set-up time.

EXCHANGE SYSTEM LEGEND

Linear arm fixture exchange system

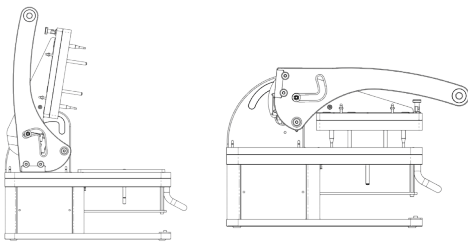

LHS2W-Standard height

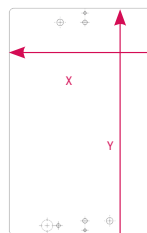

Moving plate dimension X x Y

LINEAR ARM FIXTURE EXCHANGE SYSTEM

EXCHANGEABLE BASIC UNIT

| Designation | Fixture | Moving plate (X x Y) | Pressure force | Order number |
|-------------|---|----------------------|----------------|--------------|
| LHS2WG-F |  | 200 x 130 | 200 N | 100329 |

EXCHANGEABLE CASSETTE

| Designation | Fixture | Moving plate (X x Y) | Order number |
|-------------|---|----------------------|--------------|
| LHS2WK-F |  | 200 x 130 | 100330 |

AVAILABLE HOUSING TYPES

FOR LHS2W TO FIT FLEXIBLY INTO YOUR TEST ENVIRONMENT

Housing with back panel (connectors can be mounted as required)

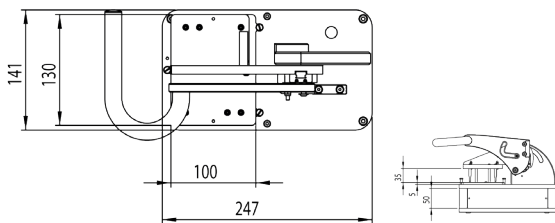

100329

Standard housing for LHS2WG-F

ACCESSORIES FOR THE LHS2-SERIES

INTERLOCKS

Electromagnetic locking

| Order number | Designation |
|--------------|--|
| 100335 | Electromagnetic locking with lifting magnet for LHS2 fixture kit |

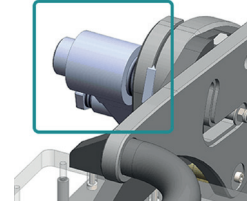

Pneumatic locking

| Order number | Designation |
|--------------|--|
| 100334 | Pneumatic locking with cylinder for LHS2 fixture kit |

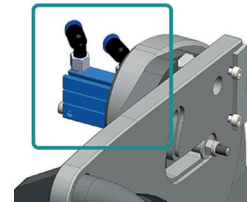

FIXTURE-CONFIGURATOR

CONFIGURE YOUR INDIVIDUAL TEST FIXTURE

LHS2-Series

Our fixture configurator was developed especially for you. Together with our sales specialists and designers, it is constantly adapted and further developed. Configure your individual test fixture now, which is specially adapted to your needs, on our homepage and receive your exclusive offer.

» **Go to configurator** (<https://www.atx-hardware.de/en/product-category/mechanical-fixture/lhs2-linear-arm-fixture/>)



ATX HARDWARE GMBH WEST

Location Pürgen | Am Kornfeld 8 | 86932 Pürgen

Location Weil im Schönbuch | Carl-Zeiss-Straße 5/1 | 71093 Weil im Schönbuch

P +49 8196 9304-0

F +49 8196 9304-19

projekte@atx-hardware.de

www.atx-hardware.de