



VACUUM
FIXTURE KIT

Imprint

Publisher:

ATX Hardware GmbH West

Am Kornfeld 8

86932 Pürgen

Germany

Phone +49 8196 9304-0

Fax + 49 8196 9304-19

E-Mail: projects@atx-hardware.de

Web: www.atx-hardware.de

CONTENTS

4	Your solution specialist
4	Fixture assembly
5	Fixture overview & Test systems
6	Vacuum Kits
7	Cobham (Aeroflex)
8	Digitaltest
10	Keysight
11	Pylon-Block
13	Seica
14	Teradyne
22	Teradyne Interface Covers
23	Vacuum exchange system
27	Vacuum cover

SPECIALIST FIXTURE SOLUTIONS

ATX is Europe's market leader in the manufacture of test fixtures for electronic test procedures. Why you too should choose an ATX fixture - it's simple:

TECHNICAL KNOW-HOW

Our sales team is highly technical - our consultants are selected from the design team or other technical departments.

PROJECT KNOW-HOW

Together with you, we work towards a common goal: to find and implement the optimal solution for your individual testing requirements.

KNOWLEDGE BASE

Our employees bring well over 1,000 man-years of Fixture building experience to the table.

SINCE 1997

CONSTRUCTION KIT

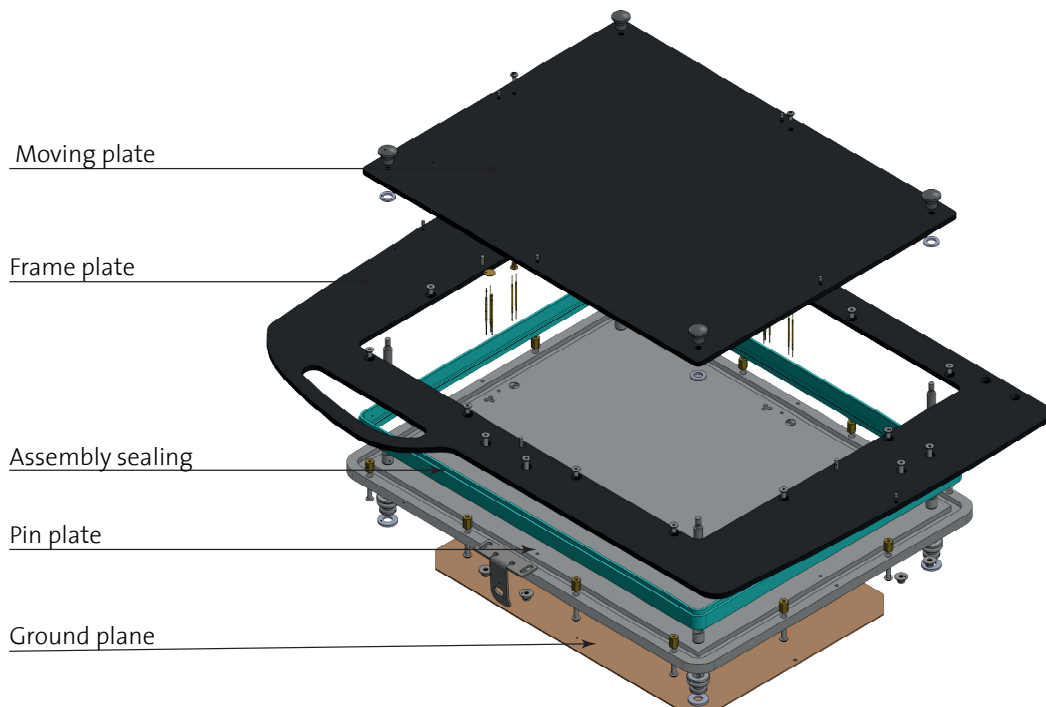

FIXTURE OVERVIEW & TEST SYSTEMS

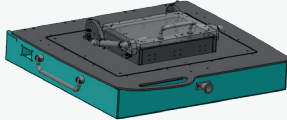
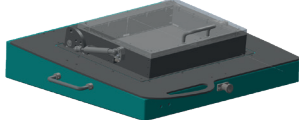
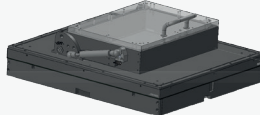
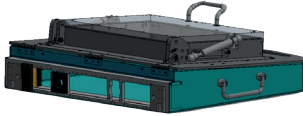
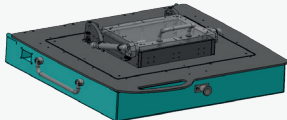
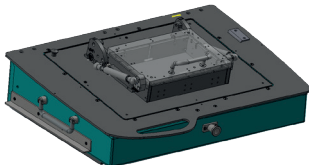
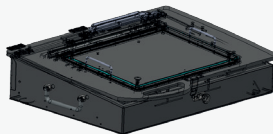
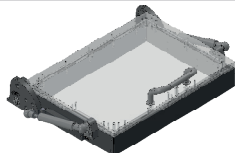
Cobham (Aeroflex)		MD 42
Digitaltest		MTS 210 MTS 300
Keysight		HP3070 small HP3070 large
Pylon-Block		Pylon 12-Fold Pylon 16-Fold
Seica		Compact V
Teradyne		<p>Teststation TS 12X (Genrad228X) 15 Slot 128 Interface max. 1536 D/S 18 Slot 128 Interface max. 1920 D/S 23 Slot 128 Interface max. 2560 D/S 33 Slot 128 Interface max. 3840 D/S</p> <p>Teststation LH 19 Slot Interface max. 4096 D/S</p> <p>Teststation Multi-Site TSA/TSO/TSI 5 Slot 256 Interface max. 1280 D/S 5 Slot HD Interface max. 2560 D/S</p> <p>Teststation Teradyne Spectrum TSSE88xx-1280 TSSE88xx-2560</p> <p>Interface Cover</p>
Exchange system		<p>WK1 + WK2 For Digitaltest MTS-300 For Teradyne TS12X (Genrad228X) For Pylon 12-Fold</p> <p>WK3 + WK4 For Digitaltest MTS-300 For Teradyne TS12X (Genrad228X)</p>
Vacuum cover		Single sided hood Standard Hood on both sides Top Access

VACUUM KITS

ASSEMBLE YOUR PRODUCT ACCORDING TO YOUR NEEDS

With us you will find powerful fixture models, adapted to your individual inspection and test environment. All fixture kits are delivered without interface and hood. These items must be ordered explicitly.

SCOPE OF DELIVERY VACUUM KIT

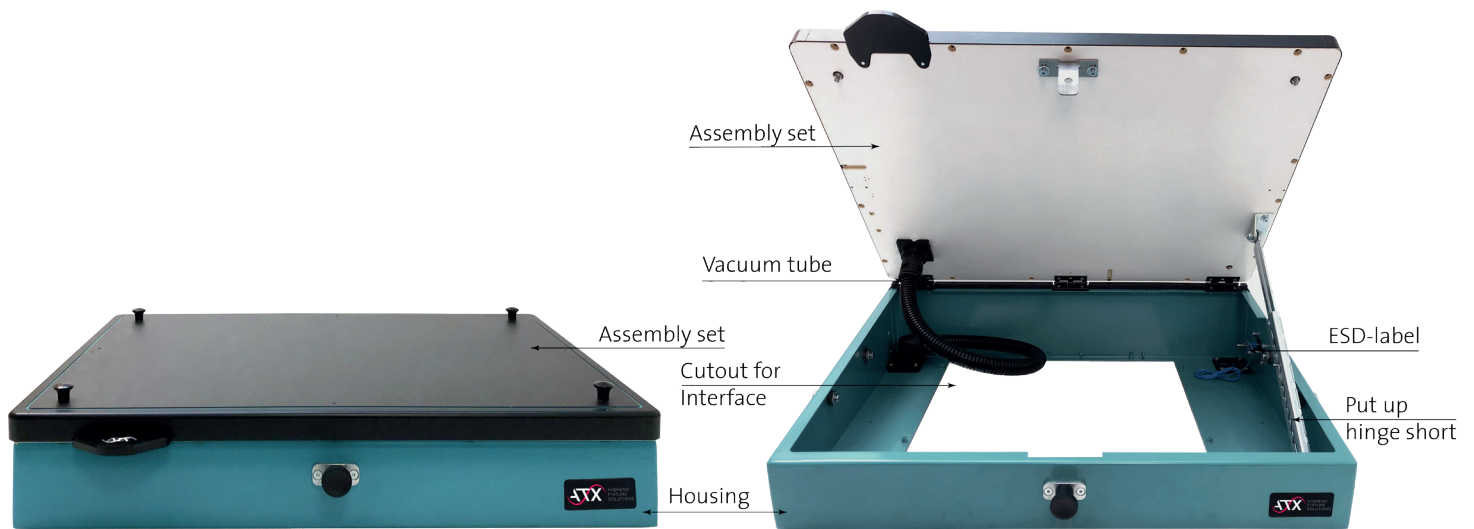

COBHAM (AEROFLEX)

TESTSTATION MD42

Interface

Order number	Designation
101435	IF-MD42 Interface unassembled MD42 Drawing No. E07-00018

Interfacecontact



Interfacepin | KT-158 02 Plan

Order number

670049

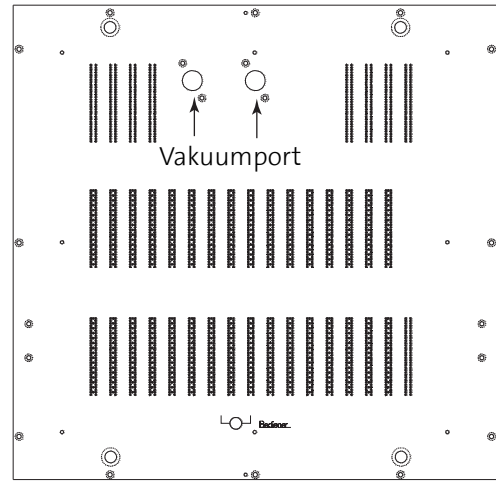

Fixture kit without interface

Order number	Designation
106004	KIT-V-2-Aeroflex-MD42-single Vacuum fixture single without Interface Housing E01-00057 Kit x 415 y 320 - B50-00025

106005	KIT-V-2-Aeroflex-MD42-single-high Vacuum fixture single without Interface High Housing E01-00052 Kit x 415 y 320 - B50-00025
--------	---

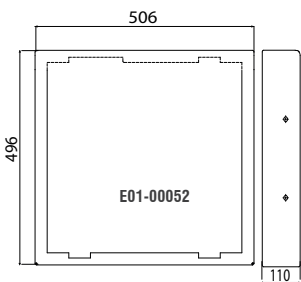
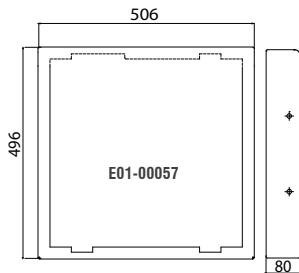
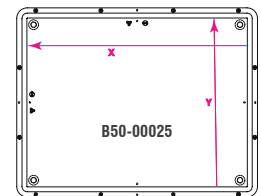

Order number	Designation
106002	KIT-V-2-Aeroflex-MD42-left Vacuum fixture single without Interface Housing E01-00010 left open Kit x 320 y 415 - B50-00053

106003	KIT-V-2-Aeroflex-MD42-left-cross Vacuum fixture single without Interface High Housing E01-00010 left open Kit x 4415 y 320 - B50-00054
--------	---

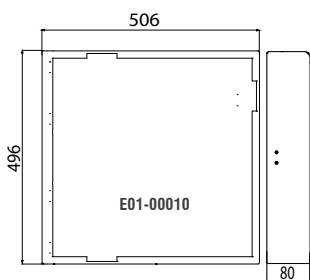
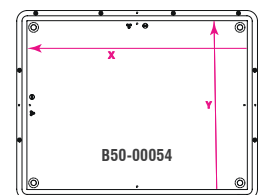
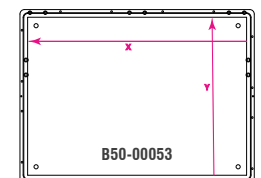

TESTSTATION MTS 210

Interface

Order number	Designation
262694	IF-MTS210 Interface unassembled MTS210 Drawing No. E07-00004

Interfacecontact



Interfacepin large inner cone | KT-158

Order number
670054

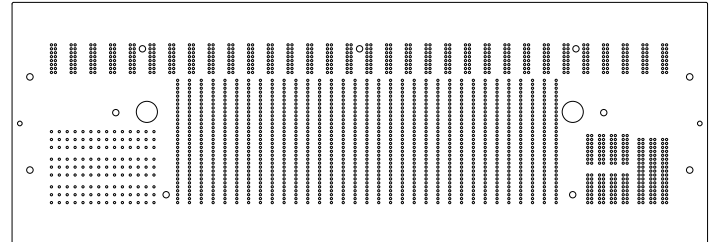

Fixture kit without interface

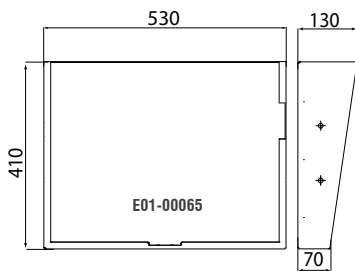

Order number	Designation
100300	KIT-V-3-Digitaltest-MTS210 Vacuum fixture single without Interface Housing E01-00065 Kit x 415 y 320 - B50-00031

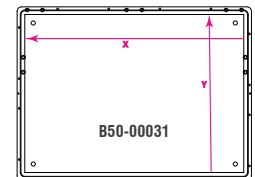

TESTSTATION MTS 300

Interface

Order number	Designation
262350	IF-MTS300 Interface unassembled MTS300 Drawing No. E07-00139

Interfacecontact



Interfacepin large inner cone | KT-158

Order number
670054

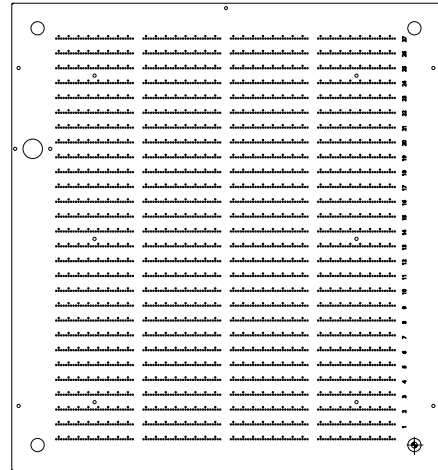

Fixture kit without interface

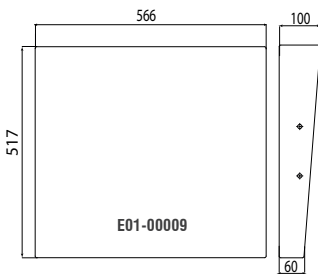

Order number	Designation
106040	KIT-V-3-Digitaltest-MTS300-single Vacuum fixture single without Interface Standard Housing E01-00009 Kit x 542 y 480 - B50-00099
106041	KIT-V-3-Digitaltest-MTS300-double Vacuum fixture Double chamber without Inter- face Standard Housing E01-00009 Double chamber x 245 y 385 - B50-00030

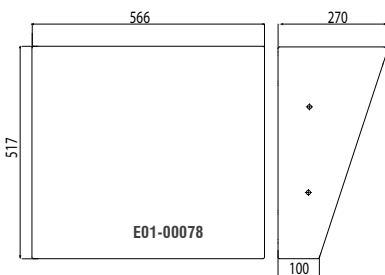
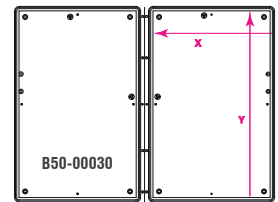
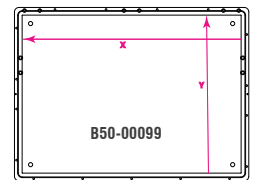

Order number	Designation
106006	KIT-V-3-Digitaltest-MTS300-single-high Vacuum fixture single without Interface Standard Housing E01-00078 Kit x 542 y 480 - B50-00099
106043	KIT-V-3-Digitaltest-MTS300-double-high Vacuum fixture Double chamber without Interface Standard Housing E01-00078 Double chamber x 245 y 385 - B50-00030

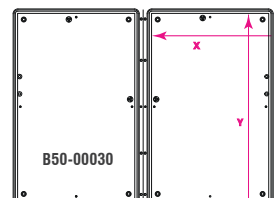
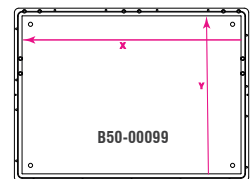

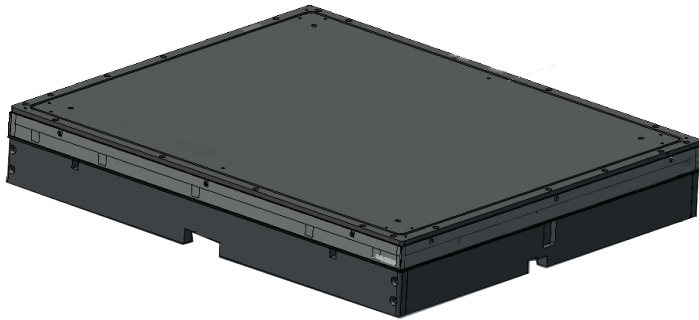

Interface contact



HP-Interfacepin
Original Agilent Perso-Pin

Order number

670030

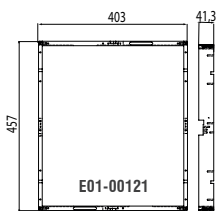

Fixture kit inclusive Alignment plate

Order number	Designation
100202	KIT-V-4-Keysight-HP3070-small Vacuum fixture single Frame Alu E01-000121 Kit x 377 y 431 - B50-00094

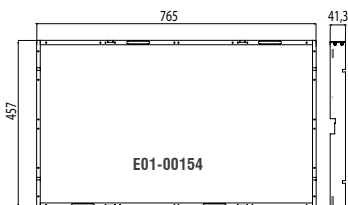
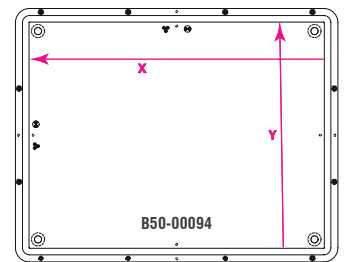

Order number	Designation
100200	KIT-V-4-Keysight-HP3070-large Vacuum fixture single Frame Alu E01-000154 Kit x 740 y 432 - B50-00101

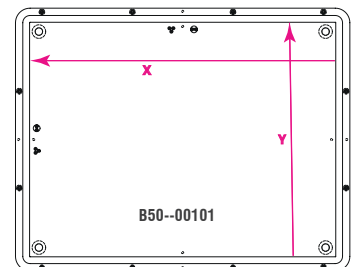

PYLON-BLOCK

12-FOLD AND 16-FOLD

Interface

Pylon blocks 12-Fold and 16-Fold



We offer a wide range of different interface blocks. You can find them in our interface blocks brochure.

U-Channel 12-Fold-Kit Drawing No. E07-00308 U-Channel 16-Fold-Kit Drawing No. E07-00070

Both U-channels are supplied with only one vacuum port as standard. If several vacuum ports are required, please let us know on your order.

Fixture kit including U-channel without interface blocks

U-Channel 12-Fold Kit

Drawing No. E07-00308

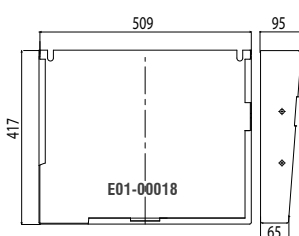
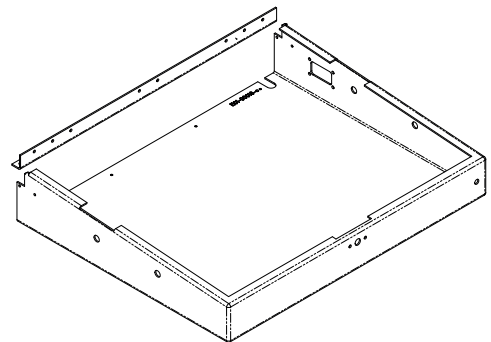
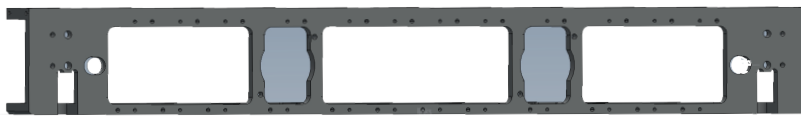

Order number	Designation
100400	KIT-V-5-Pylon-Block-12Fold-single Vacuum fixture single incl. U-Chanel and 1 Vacuumport, without IF-Blocks Housing E01-00018 Kit x 485 y 380 - B50-00095
106008	KIT-V-5-Pylon-Block-12Fold-double Vacuum fixture Double chamber incl. U-Channel and 2 Vacuumport without IF-Blocks Housing E01-00018 Double chamber x 242,5 y 380 - B50-00103

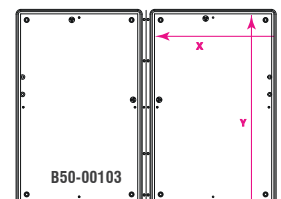
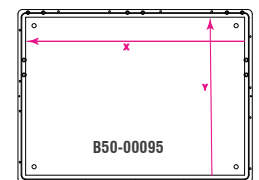

PYLON-BLOCK

12-FOLD AND 16-FOLD

Fixture kit including U-channel without interface blocks

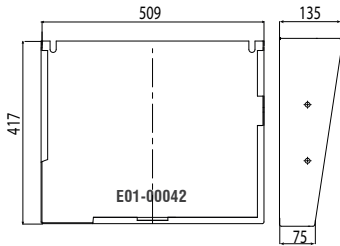

Order number	Designation
106009	KIT-V-5-Pylon-Block-12Fold-single-high Vacuum fixture single incl. U-Channel and 1 Vacuumport, without IF-Blocks Housing E01-00042 Kit x 485 y 380 - B50-00095
106010	KIT-V-5-Pylon-Block-12Fold-double-high Vacuum fixture Double chamber incl. U-Channel and 2 Vacuumport, without IF-Blocks Housing E01-00042 Double chamber x 242,5 y 380 - B50-00103

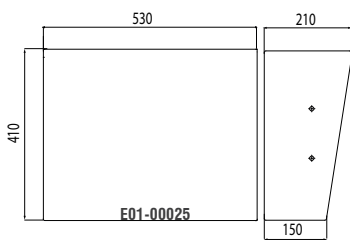
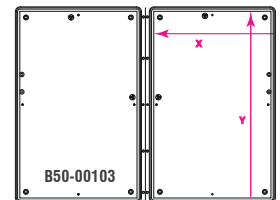
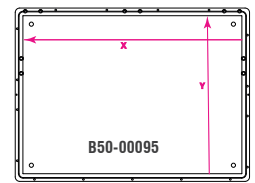

Order number	Designation
106011	KIT-V-5-Pylon-Block-12Fold-single-exhigh Vacuum fixture single incl. U-Channel and 1 Vacuumport, without IF-Blocks Housing E01-00025 Kit x 515 y 385 - B50-00098
106012	KIT-V-5-Pylon-Block-12Fold-double-exhigh Vacuum fixture Double chamber incl. U-Channel and 2 Vacuumport, without IF-Blocks Housing E01-00025 Double chamber x 265 y 365 - B50-00049

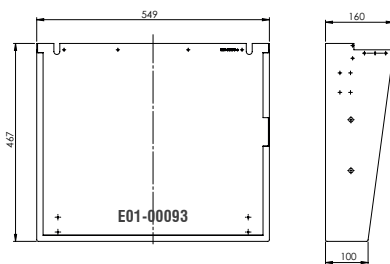
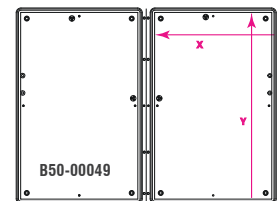
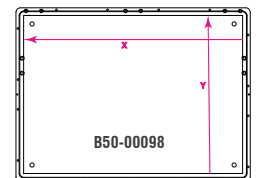

Order number	Designation
106050	KIT-V-5-Pylon-Block-12Fach-single-hoch Vakuuadapter single inkl. U-Channel und 1 Vakuumport, ohne IF-Blöcke Gehäuse E01-00093 Bausatz x 580 y 525 - B50-00093

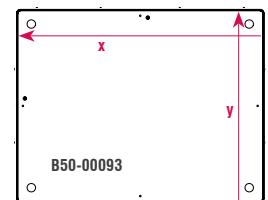

U-Channel 16-Fold Kit Drawing No. E07-00070

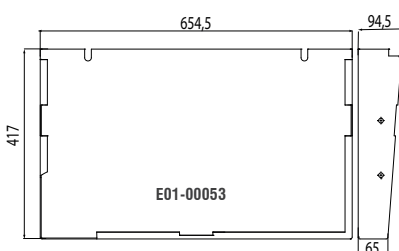
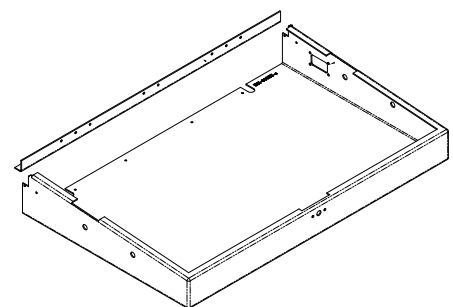

Order number	Designation
100469	KIT-V-5-Pylon-Block-16Fold Vacuum fixture single incl. U-Channel and 1 Vacuumport, without IF-Blocks Housing E01-00053 Kit x 630,5 y 380 - B50-00097

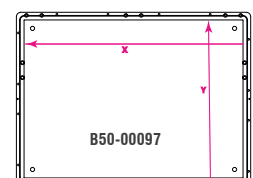

TESTSTATION COMPACT-V

Seica-PM-Y1801330

Interface

Order number	Designation
584007	IF-Seica-PM Interface unassembled Drawing No. B10-00015 incl. RFID-Chip

Interfacecontact | Accessories



Interfacepin | KT-158 02
Plan

Order number
670049



RFID Chip Transponder
RTP-0301-020

Order number
549169

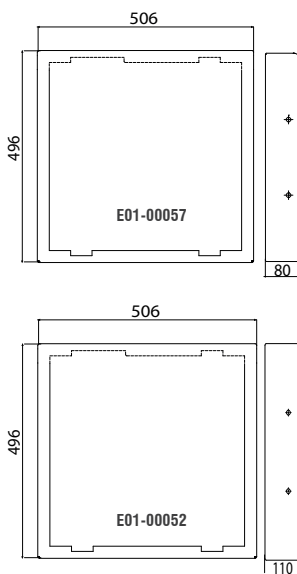
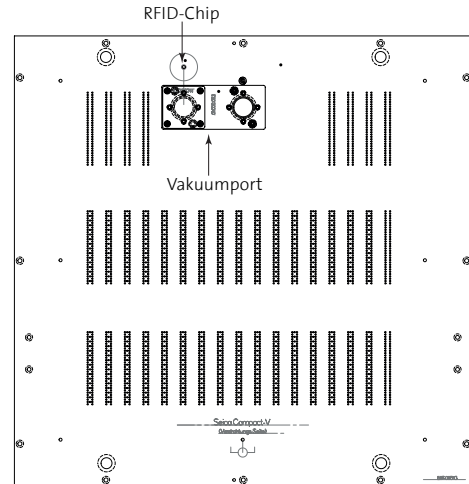

Fixture kit without interface

Order number	Designation
106014	KIT-V-6-Seica-PM-Y1801330-single Vacuum fixture single without Interface Housing E01-00057 Kit x 415 y 320 - B50-00025
106015	KIT-V-6-Seica-PM-Y1801330-single-high Vacuum fixture single without Interface High Housing E01-00052 Kit x 415 y 320 - B50-00025

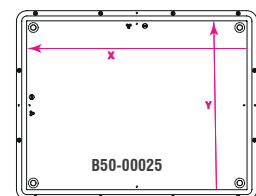

TESTSTATION TS 12X (GENRAD228X) AND LH | INTERFACE 15 SLOT AND 18 SLOT

15 Slot 128 Interface max. 1536 D/S

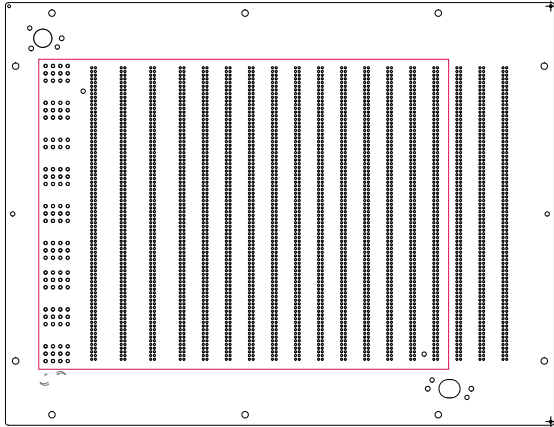

Interface

Order number	Designation
584003	IF-TER-GR228x-15 Interface unassembled 15Slot Drawing No. E07-00265
101100	IF-TER-GR228x-15-1 Interface partially equipped with 512 D/S (Slot 0 and 1 unassembled)
101102	IF-TER-GR228x-15-2 Interface partially equipped with 1024 D/S (Slot 0 and 1 unassembled)
101104	IF-TER-GR228x-15-3 Interface fully equipped with 1536 D/S (Slot 0 and 1 unassembled)

15 Slot 128 Interface max. 1536 D/S

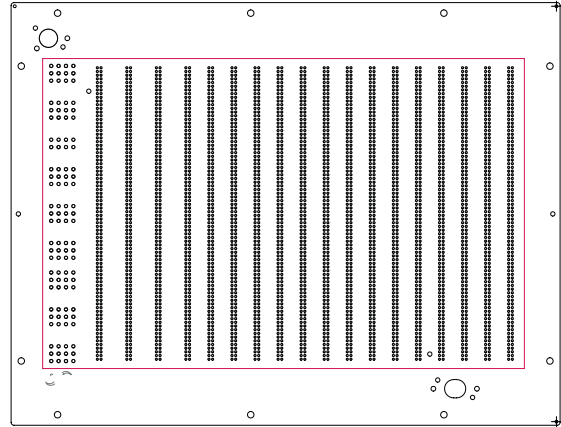

Interface

Order number	Designation
584004	IF-TER-GR228x-18 Interface unassembled 18Slot Drawing No. E07-00266
101106	IF-TER-GR228x-18-1 Interface fully equipped with 1920 D/S (Slot 0 and 1 unassembled)

Interface contact



Interfacepin
KT-158 02 Plan

Order number

670049



Powersip Solder GPP

Order number

699003



Powersip WireWrap
FK 521

Order number

699004

Fixture kit | Lift rails

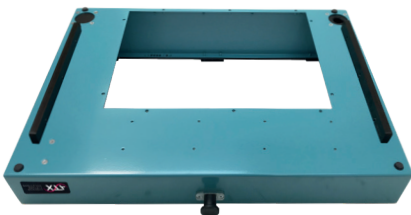

Interface protection
Drawing No. E90-50123

Order number

263331

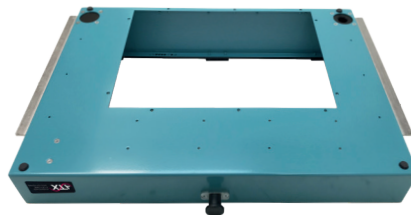

Lift rails
Drawing No. E01-00075

Order number

304116



Protective strip angle
Drawing No. E01-00086 | E01-00087

Order number

304104 | 304125

TESTSTATION TS 12X (GENRAD228X) AND LH | INTERFACE 15 SLOT AND 18 SLOT

Fixture kit without interface

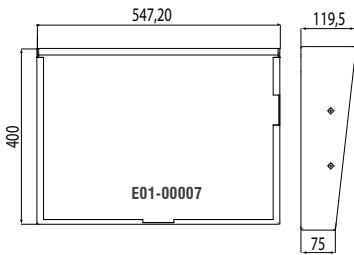

Order number	Designation
100118	KIT-V-1-Teradyne-TS12X IF15+ 18 Slot-single Vacuum fixture single without Interface Housing E01-00007 Kit x 523,2 y 380 - B50-00096
106019	KIT-V-1-Teradyne-TS12X-IF 15+ 18 Slot-double Vacuum fixture Double chamber without Interface Housing E01-00007 Double chamber x 246,6 y 380 - B50-00106

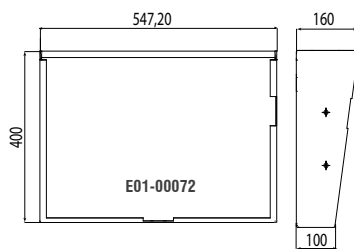
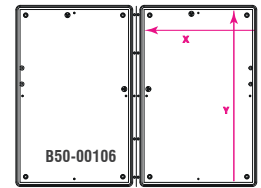
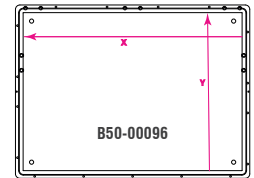

Order number	Designation
106020	KIT-V-1-Teradyne-TS12x-IF 15+ 18 Slot-single-high Vacuum fixture single without Interface High Housing E01-00072 Kit x 523,2 y 380 - B50-00096
106021	KIT-V-1-Teradyne-TS12X-IF 15+ 18 Slot-double-high Vacuum fixture Double chamber without Interface High Housing E01-00072 Double chamber x 246,6 y 380 - B50-00106

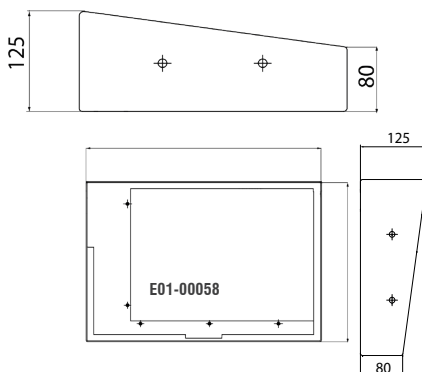
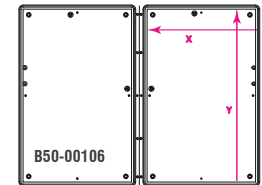
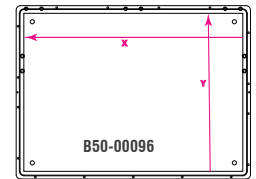

Order number	Designation
100361	KIT-V-1-Teradyne-TS12x-IF15+ 18Slot-Single-high Vacuum fixture single without Interface High Housing E01-00058 Kit x 430 y 299 - B50-00125

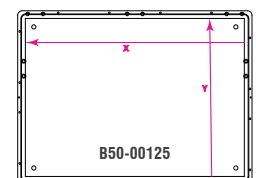

TESTSTATION TS 12X (GENRAD228X) AND LH | INTERFACE 23 SLOT

23 Slot 128 Interface max. 1536 D/S

Interface

Order number	Designation
584001	IF-TER-GR228x-23 Interface unassembled 23 Slot Drawing No. E07-000267
101108	IF-TER-GR228x-23-1 Interface partially equipped with 2048 D/S (Slot 0 and 1 unassembled)
110110	IF-TER-GR228x-23-2 Interface fully equipped with 2560 D/S (Slot 0 and 1 unassembled)

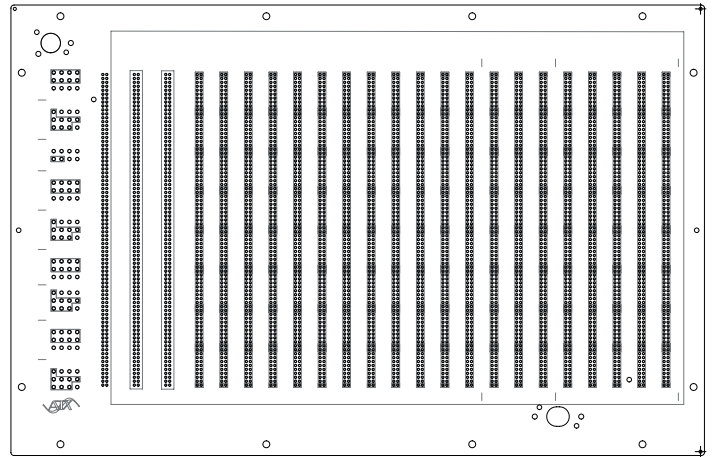

Interface contact



Interface pin
KT-158 02 Plan



Powersip Solder GPP



Powersip WireWrap
FK 521

Order number	Order number	Order number
670049	699003	699004

Fixture kit without interface

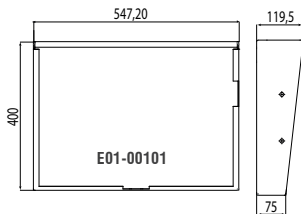

Order number	Designation
100100	KIT-V-1-Teradyne-TS12X-IF 23 Slot-single Vacuum fixture GR228x single without Interface Housing E01-00101 Kit x 523,2 y 380 - B50-00096
106022	KIT-V-1-Teradyne-TS12X-IF 23 Slot-double Vacuum fixture GR228x double without Interface Housing E01-00101 Double chamber x 246,6 y 380 - B50-00106

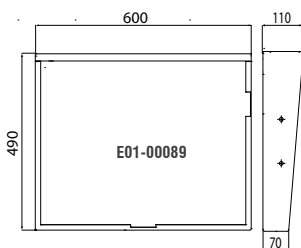
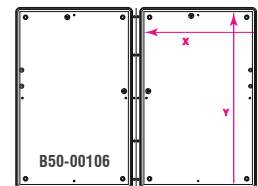
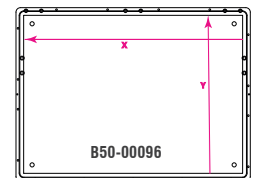

Order number	Designation
100122	KIT-V-1-Teradyne-TS12X-IF 23 Slot-single-wide Vacuum fixture GR228x single without Interface Housing E01-00089 Kit x 615 y 430 - B50-00087

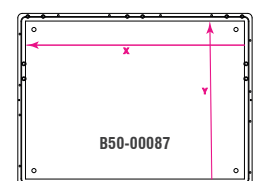

TESTSTATION TS LX (GENRAD 228X) | INTERFACE 33 SLOT

33 Slot 128 Interface max. 3840 D/S

Interface

Order number	Designation
584005	IF-TER-GR228x-33 Interface unassembled 33 Slot Drawing No. E07-00270
580010	IF-TER-GR228x-33-1 Interface fully equipped with 3840 D/S (Slot 0 and 1 unassembled)
1584006	IF-TER-Gr228x-DUO Interface unassembled 33 Slot DUO Drawing No. E07-00264

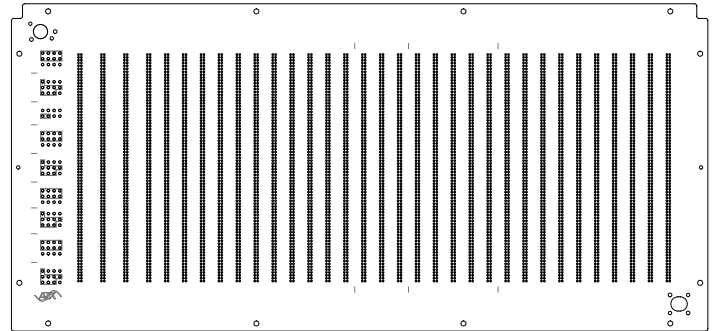

Interface contact



Interfacepin
KT-158 02 Plan



Powersip Solder GPP



Powersip WireWrap
FK 521

Order number
670049

Order number
699003

Order number
699004

Fixture kit without interface

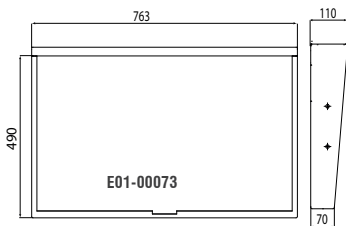

Order number	Designation
100102	KIT-V-1-Teradyne-TS12x (Genrad 228x)-IF 33 Slot Vacuum fixture single without Interface Housing E01-00073 Kit x 739 y 465 - B50-00124

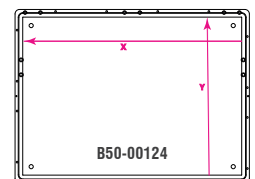

TESTSTATION LH | INTERFACE 19 SLOT

19 Slot Interface max. 4096 D/S

Interface

Order number	Designation
304133	IF-TEr-LH-19Slot Interface unassembled 19 Slot Drawing No. E07-00024

Interface contact



Interfacepin
KT-158 02 Plan



Powersip Solder GPP



Powersip WireWrap
FK 521

Order number
670049

Order number
699003

Order number
699004

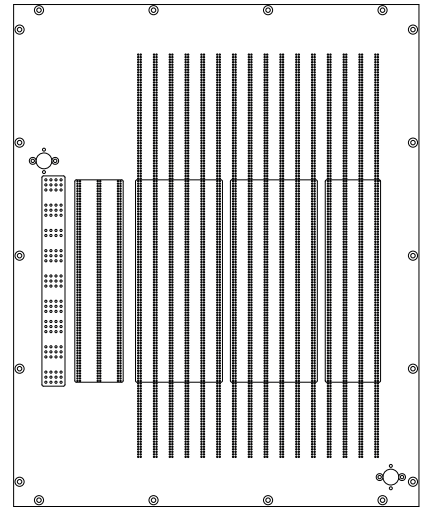

Fixture kit without interface

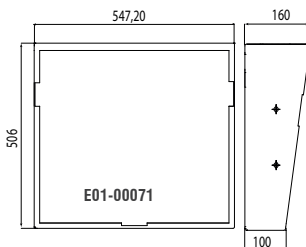

Order number	Designation
106047	KIT-V-1-Teradyne-LH-IF 19 Slot-single Vacuum fixture single without Interface Housing E01-00071 Kit x 523,2 y 380 - B50-00096
106018	KIT-V-1-Teradyne-LH-IF 19 Slot-doublet Vacuum fixture Double chamber without Interface Housing E01-00071 Double chamber x 246,6 y 380 - B50-00106

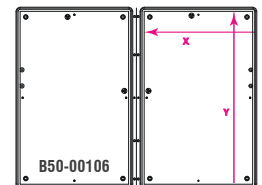
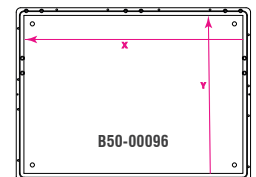

TESTSTATION MULTI-SITE TSA/TSO/TSI

5 Slot 256 Interface max. 1280 D/S

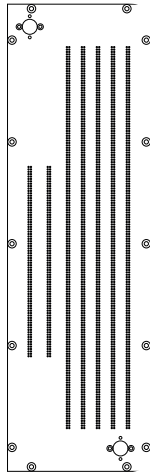

Interface

5 Slot 512 HD Interface max. 2560 D/S

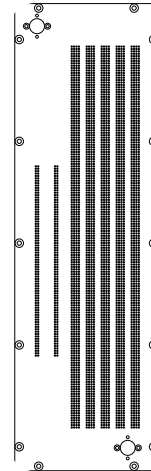

Interface

Interfacecontact



Interfacepin | KT-158 02 Plan

Order number

670049

Order number	Designation
581015	IF-TER-TSA/O/H-256 Interface unassembled 5 Slot Drawing No. B10-00001
581008	IF-TER-TSA/O/H-256 voll Interface fully equipped with 1280 D/S

Order number	Designation
581016	IF-TER-TSA/O/H/-HD Interface unassembled 5 Slot Drawing No. B10-00008
581007	IF-TER-TSA/O/H/HD voll Interface fully equipped with 2560 D/S

Fixture kit without interface

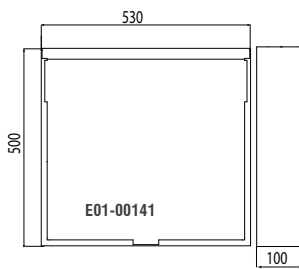

Order number	Designation
100225	KIT-V-1-Teradyne-TSO-TSA-1-single-small Vacuum fixture single without Interface Housing E01-00141 Kit x 506 y 476 - B50-00116

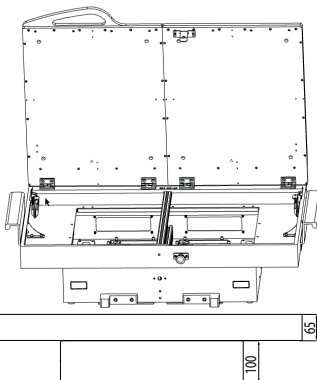
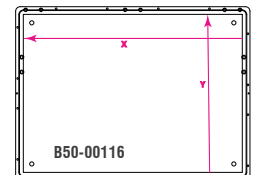

Order number	Designation
106024	KIT-V-1-Teradyne-TSO-TSA-2-double Vacuum fixture Double chamber without Interface Housing E01-00141 Double chamber x 238 y 380 - B50-00117

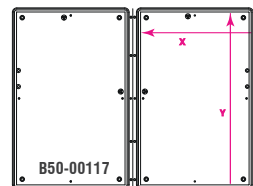

Order number	Designation
100226	KIT-V-1-Teradyne-TSO-TSA-3-single-wide Vacuum fixture single without Interface Housing E01-00140 + E01-00141 Kit x 736 y 380 - B50-00120

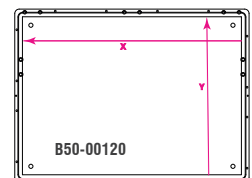

Order number	Designation
100227	KIT-V-1-Teradyne-TSO-TSA-4-double-wide Vacuum fixture single without Interface Housing E01-00140 + E01-00141 Double chamber x 353 y 476 - B50-00121

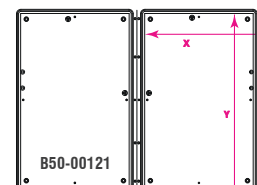

TESTSTATION SPECTRUM | TSSE88XX-1280

TSSE88xx-1280

Interface

Order number	Designation
581013	IF-TER-TSSE88xx-1280 Interface unassembled TSSE88xx-1280 Drawing No. E07-00006
580012	IF-TER-TSSE88xx-1280 voll Interface fully equipped with 1280 D/S (Slot 0 and 1 unassembled)

Interface contact



Interfacepin
KT-158 02 Plan

Order number

670049



Powersip WireWrap
FK 521

Order number

699004

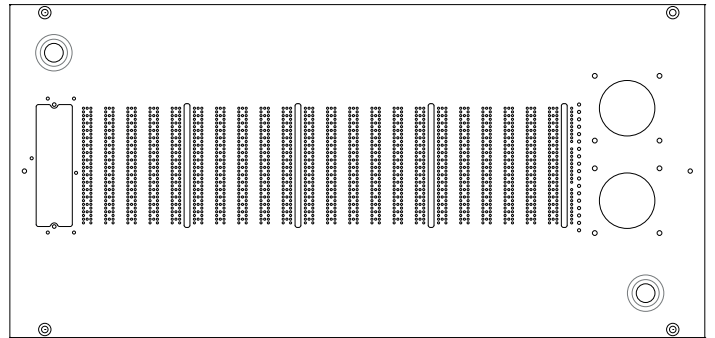

Fixture kit without interface

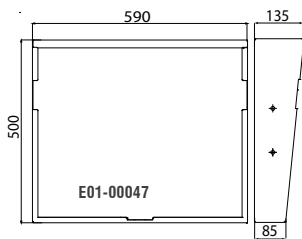

Order number	Designation
106038	KIT-V-1-Teradyne-Spectrum (TSSE88xx-1280)-single Vacuum fixture single without Interface Housing E01-00047 Kit x 566 y 480 - B50-00100
1106037	KIT-V-1-Teradyne-Spectrum (TSSE88xx-1280)-double Vacuum fixture double without Interface Housing E01-00047 Double chamber x 320 y 415 - B50-00071

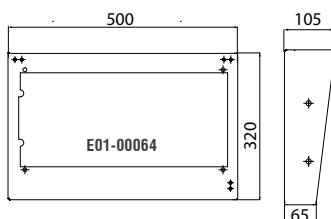
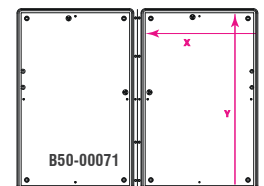
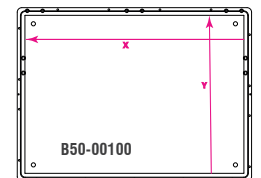

Order number	Designation
106039	KIT-V-1-Teradyne-Spectrum (TSSE88xx-1280)-small Vacuum fixture single without Interface Housing E01-00064 Kit x 365 y 265 - B50-00084

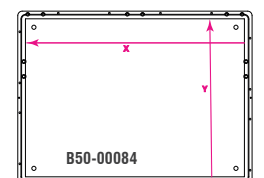

TESTSTATION SPECTRUM | TSSE88XX-2560

TSSE88xx-2560

Interface

Order number	Designation
581014	IF-TER-TSSE88xx-2560 Interface unassembled TSSE88x-2560 Drawing No. E07-00007
580013	IF-TER-TSSE88xx-2560 voll Interface fully equipped with 2560 D/S (Slot 0 and 1 unassembled)

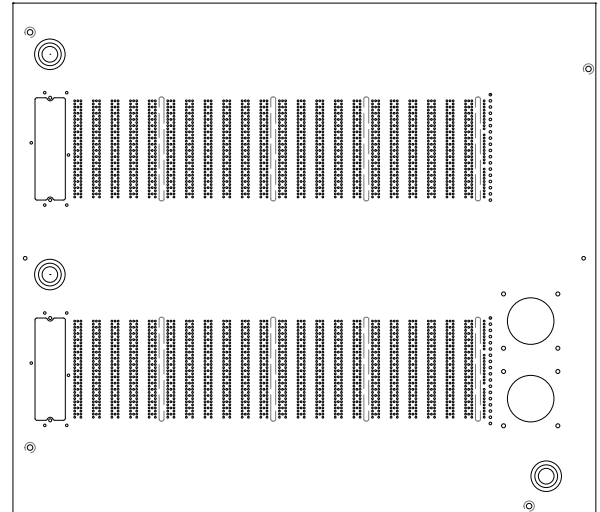

Interface contact



Interfacepin
KT-158 02 Plan

Order number

670049



Powersip WireWrap
FK 521

Order number

699004

Fixture kit without interface

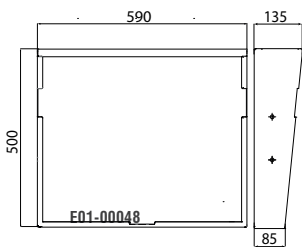

Order number	Designation
100119	KIT-V-1-Teradyne-Spectrum (TSSE88xx.2560)-single Vacuum fixture single without Interface Housing E01-00048 Kit x 566 y 480 - B50-00100
106025	KIT-V-1-Teradyne-Spectrum (TSSE88xx-2560)-double Vacuum fixture double without Interface Housing E01-00048 Double chamber x 320 y 415 - B50-00071

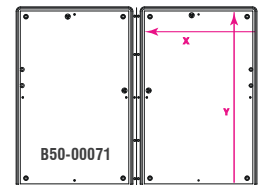
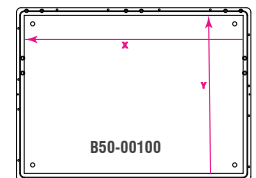

INTERFACE COVER

Testsystem LH

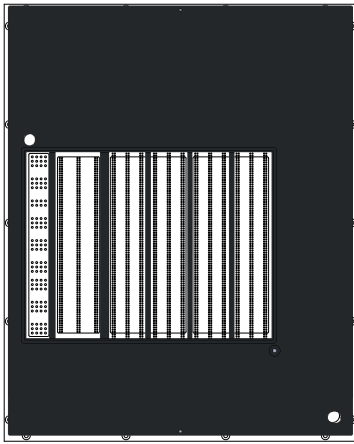

Order number	Designation
101433	Fixture Interface 19 Slot 256 Pin Card Slot- Pinnumber Genrad 8x 128 Pin 0-15 Slot 1536 D/S Drawing No. E07-00272

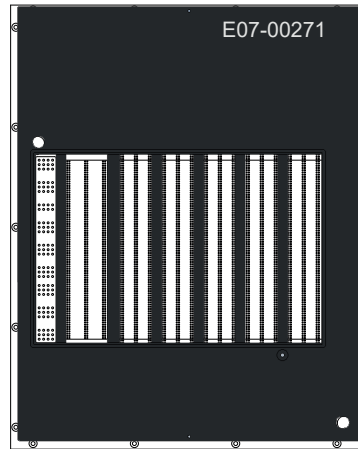

Order number	Designation
101151	Fixture Interface 19 Slot 256 Pin Card Slot- Pinnumber Genrad 8x 128 Pin 0-18 Slot 1920 D/S Drawing No. E07-00271

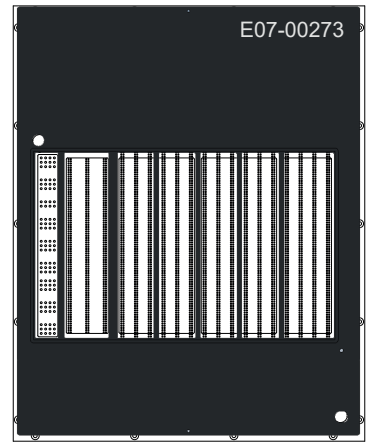

Order number	Designation
101153	Fixture Interface 19 Slot 256 Pin Card Slot- Pinnumber Genrad 8x 128 Pin 0-19 Slot 2048D/S Drawing No. E07-00273

Testsystem LH

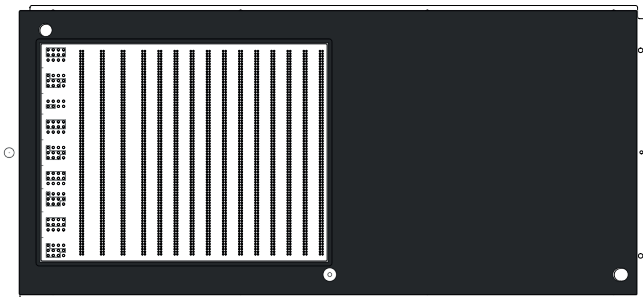

Order number	Designation
101150	Fixture Interface 33 Slot 128 Pin Card Slot- Pinnumber Genrad 8x 128 Pin 0-15 Slot 1536 D/S Drawing No. E07-00133

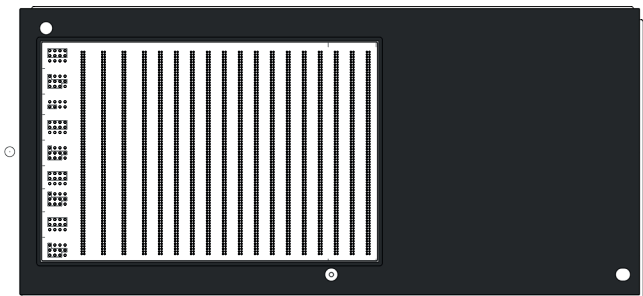

Order number	Designation
101152	Fixture Interface 33 Slot 128 Pin Card Slot- Pinnumber Genrad 8x 128 Pin 0-18 Slot 1920 D/S Drawing No. E07-00134

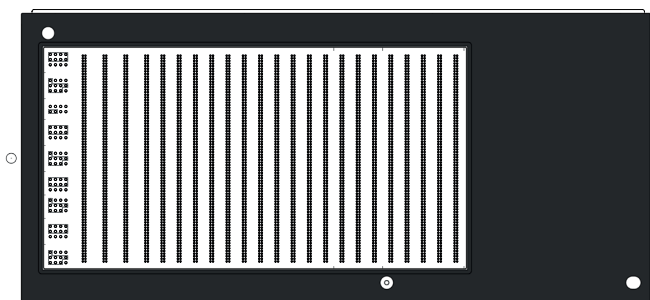

Order number	Designation
101154	Fixture Interface 33 Slot 128 Pin Card Slot- Pinnumber Genrad 8x 128 Pin 0-23 Slot 12560 D/S Drawing No. E07-00135

VACUUM EXCHANGE SYSTEM

WK2

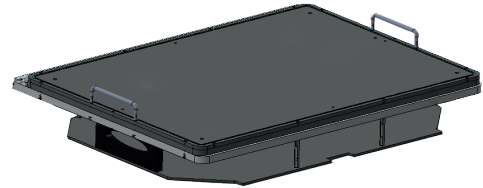
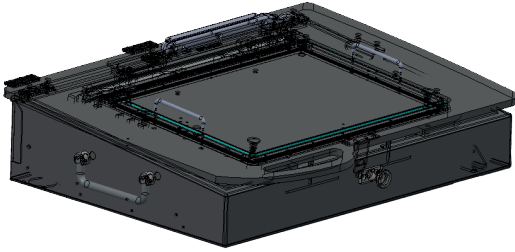

Standard

Order number	Designation
100402	WK1 Interchangeable cassette for 840 Transfer contacts

The vacuum exchange system of ATX is test system independent and can therefore be adapted to all systems.

- Aeroflex
- Digitaltest
- Seica
- Pylon-Block
- Teradyne

Interface contact Basic device



Sleeve 100mil 5mm
H502WW

Order number
681002



Pin Wafer 100mil
F562 06B 190 G 100

Order number
630001

Interface contact Interchangeable cassette



Interface pin plan WW
I-G1S1

Order number
670001

Kit Interchangeable cassette

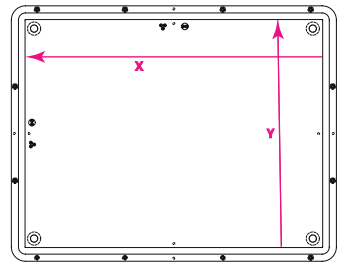

Expansion to digital test

Order number	Designation
262350	IF-MTS-300 Interface unassembled MTS300 Drawing No. E07-00139

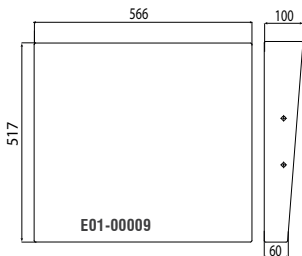

E01-00009

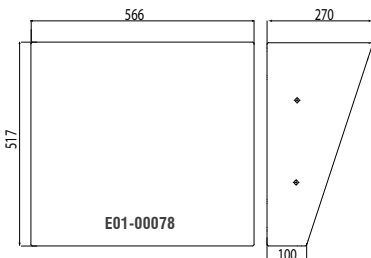

E01-00078

Order number	Designation
106026	KIT-V-3-Digitaltest-WK2-MTS300 Basic Device WK2 without Interchangeable cassette WK1 Housing E01-00009 Kit WK1 x 365 y 265 - B50-00041
106027	KIT-V-3-Digitaltest-WK2-MTS300-high Basic Device WK2 without Interchangeable cassette WK1 High Housing E01-00078 Kit WK1 x 365 y 265 - B50-00041

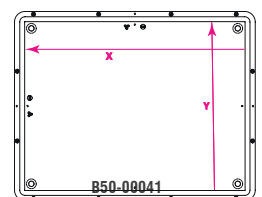

B50-00041

VACUUM EXCHANGE SYSTEM

WK2

Test fixture for Teradyne

Order number	Designation
584003	IF-TER-GR228X-15 Interface unassembled 15 Slot Drawing No. E07-00265

Order number	Designation
584004	IF-TER-GR228X-18 Interface unassembled 18 Slot Drawing No. E07-00266

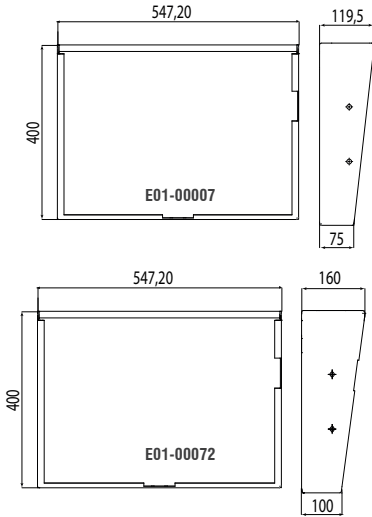

Order number	Designation
106028	KIT-V-1-Teradyne-WK2-TS12x-IF 15+ 18 Slot Basic Device WK2 without Interchangeable cassette WK1 Housing E01-00007 Kit WK1 x 365 y 265 - B50-00041
106029	KIT-V-1-Teradyne-WK2-TS12x-IF 15+ 18 Slot-high Basic Device WK2 without Interchangeable cassette WK1 High Housing E01-00072 Kit WK1 x 365 y 265 - B50-00041

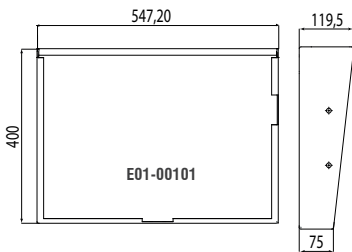
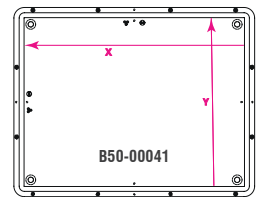

Order number	Designation
106030	KIT-V-1-Teradyne-WK2-TS12X (GR228X)-IF 23 Slot Basic Device WK2 without Interchangeable cassette WK1 Housing E01-00101 Kit WK1 x 365 y 265 - B50-00041

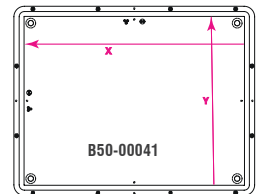

Test fixture for Teradyne

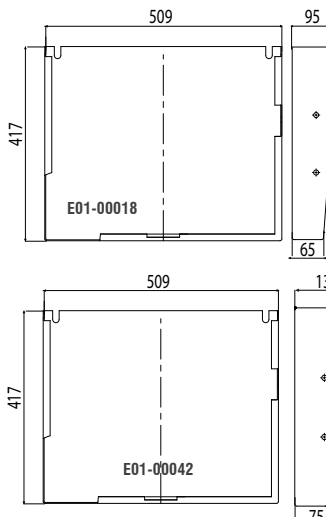

Order number	Designation
106031	KIT-V-5-Pylon-Block-12Fold-WK2 Basic Device WK2 without Interchangeable cassette WK1 incl. U-Channel 12-Fold Housing E01-00018 Kit x 365 y 265 - B50-00041
106032	KIT-V-5-Pylon-Block-12Fold-Wk2-high Basic Device WK2 without Interchangeable cassette WK1 incl. U-Channel 12-Fold High Housing E01-00042 Kit Wk1 x 365 y 265 - B50-00041

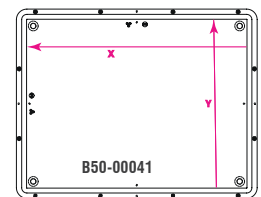

VACUUM EXCHANGE SYSTEM

WK4

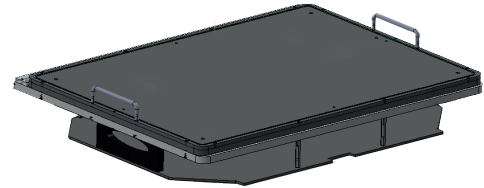
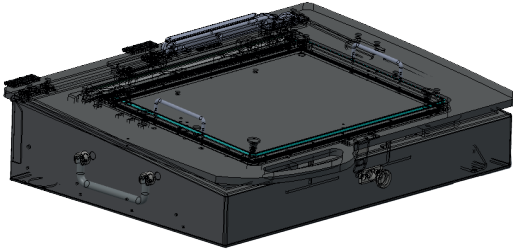

Standard

Order number	Designation
100406	WK3 Interchangeable cassette for 1303 Transfer contacts

The vacuum exchange system of ATX is test system independent and can therefore be adapted to all systems.

- Aeroflex
- Digitaltest
- Seica
- Pylon-Block
- Teradyne

Interface contact Basic Device



Sleeve 100mil 5mm
H502WW

Order number
681002



Pin Wafer 100mil
F562 06B 190 G 100

Order number
630001

Interface contact Interchangeable cassette Kit Interchangeable cassette



Interfacepin plan WW
I-G1S1

Order number
670001

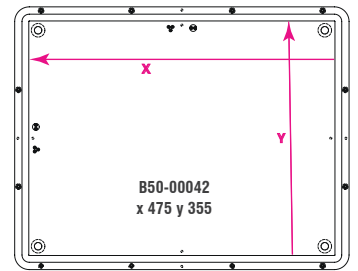

Expansion to digital test

Order number	Designation
262350	IF-MTS-300 Interface unassembled MTS300 Drawing No. E07-00139

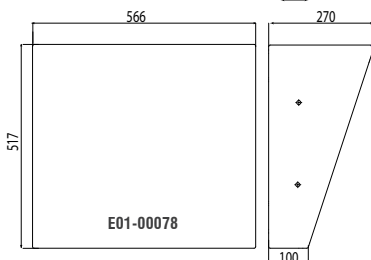
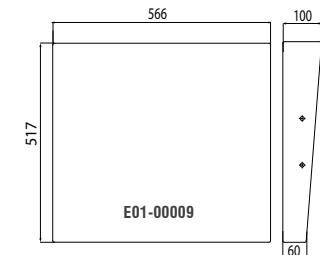

Order number	Designation
106033	KIT-V-3-Digitaltest-WK4-MTS300 Basic Device WK4 without Interchangeable cassette WK3 Housing E01-00009 Kit WK3 x 475 y 335 - B50-00042
106034	KIT-V-3-Digitaltest-WK4-MTS300-high Basic Device WK4 without Interchangeable cassette WK3 High Housing E01-00078 Kit WK3 x 475 y 335 - B50-00042

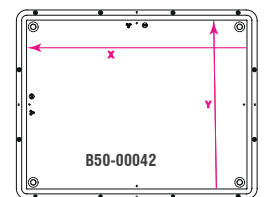

VACUUM EXCHANGE SYSTEM

WK4

Expansion on Teradyne

Order number	Designation
584003	IF-TER-GR228X-15 Interface unassembled 15 Slot Drawing No. E07-00265

Order number	Designation
584004	IF-TER-GR228X-18 Interface unassembled 18 Slot Drawing No. E07-00266

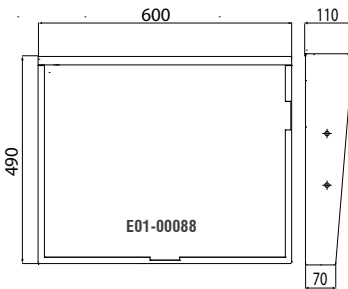

Order number	Designation
106035	KIT-V-1-Teradyne-WK4-TS12x (GR228x)-IF 15+18 Slot Basic Device WK4 without Interchangeable cassette WK3 Housing E01-00088 Kit WK3 x 475 y 335 - B50-00042

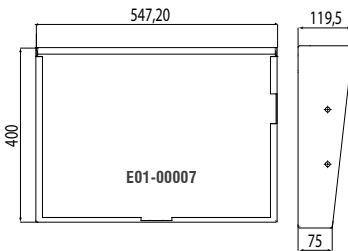
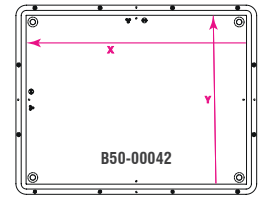

Order number	Designation
106049	KIT-V-1-Teradyne-WK4-TS12x (GR228x)-LH Basic Device WK4 without Interchangeable cassette WK3 Housing E01-00007 Kit WK3 x 475 y 335 - B50-00042

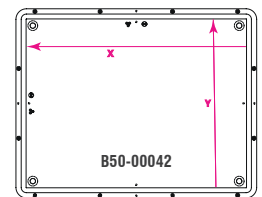

Order number	Designation
584001	IF-TER-GR228x-23 Interface unassembled 23 Slot Drawing No. E07-00267

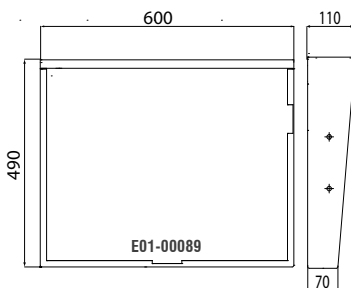

Order number	Designation
106036	KIT-V-1-Teradyne-WK4-TS12x (GR228x)-IF 23Slot Basic Device WK4 without Interchangeable cassette WK3 Housing E01-00089 Kit WK3 x 475 y 335 - B50-00042

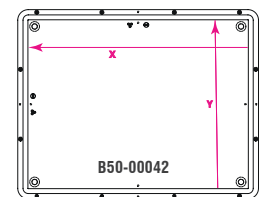

VACUUM COVER

SINGLE SIDED HOOD | STANDARD

The ATX Vacuum covers are supplied with patented precision bearings. The spring-loaded drainage element allows the hoods to be particularly well balanced, making them extremely user-friendly and easy to operate. The precision bearings ensure a secure position of the hold-downs even with tightly assembled assemblies. Hold-downs, PCB supports, catch pins and other accessories can be found in our catalog for [Fixture Accessories](#).

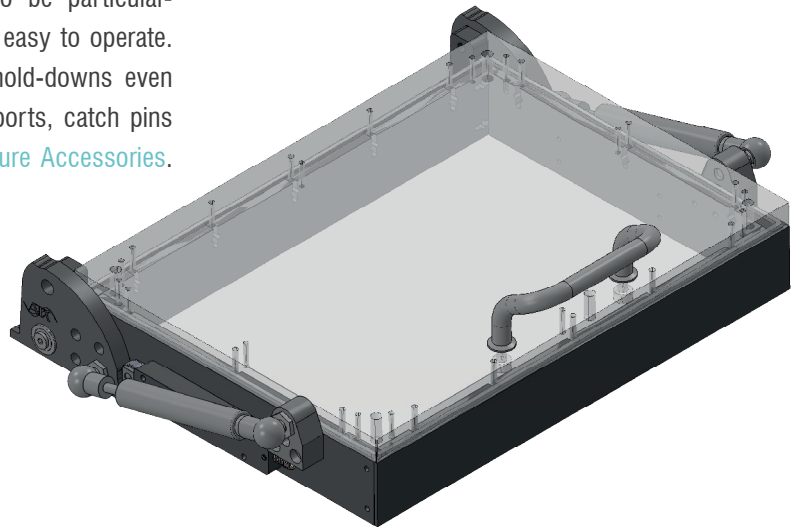

Outer and Inner dimension

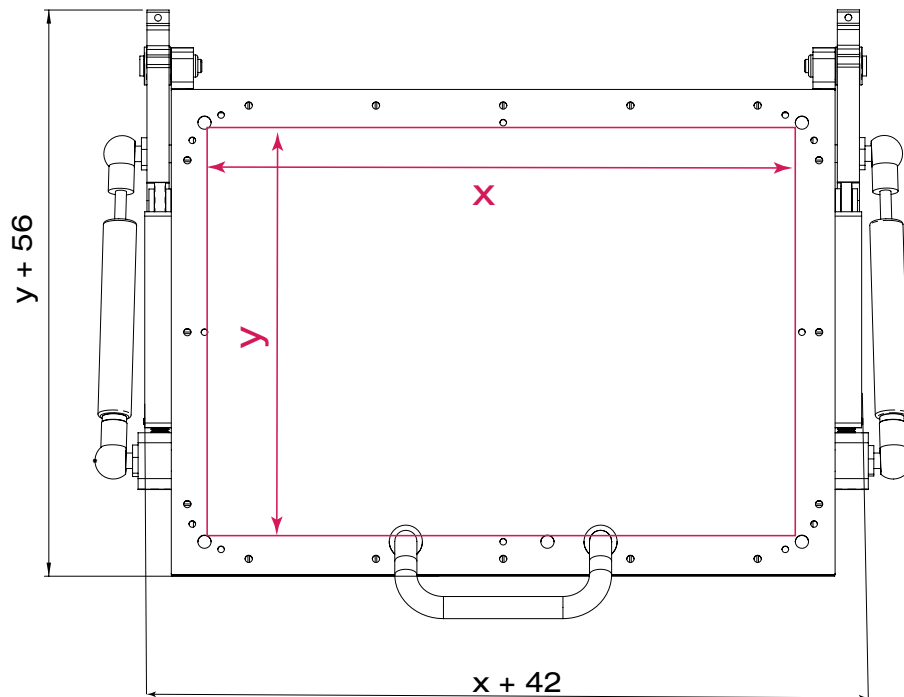

Height dimension

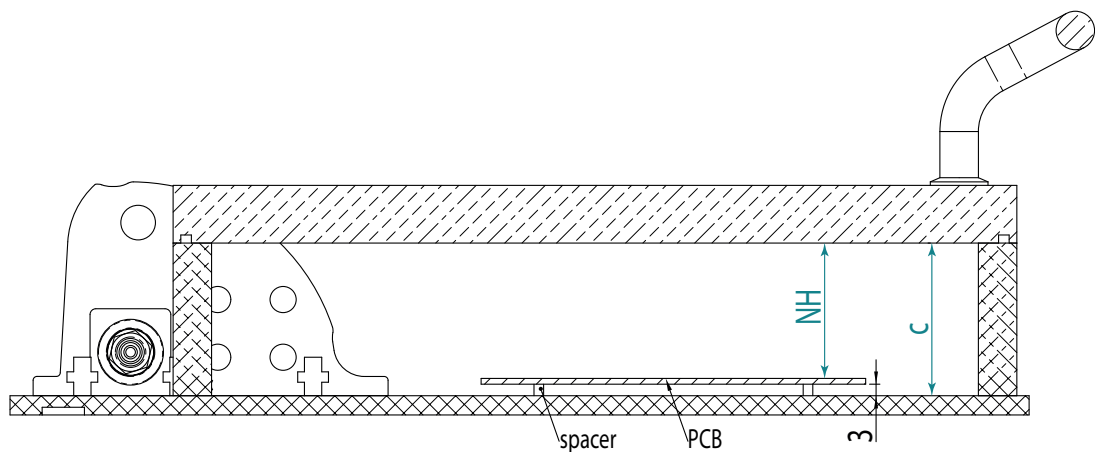

VACUUM COVER

DOUBLE-SIDED HOOD | TOP ACCESS

Structure of the hood

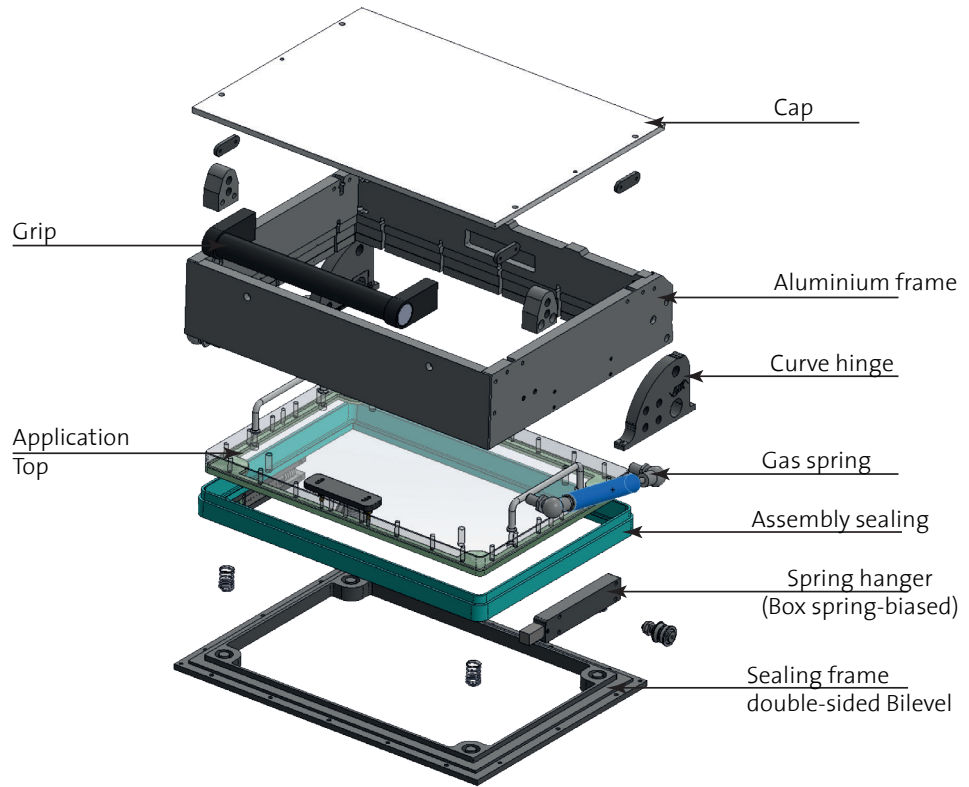

Outer and Inner dimension

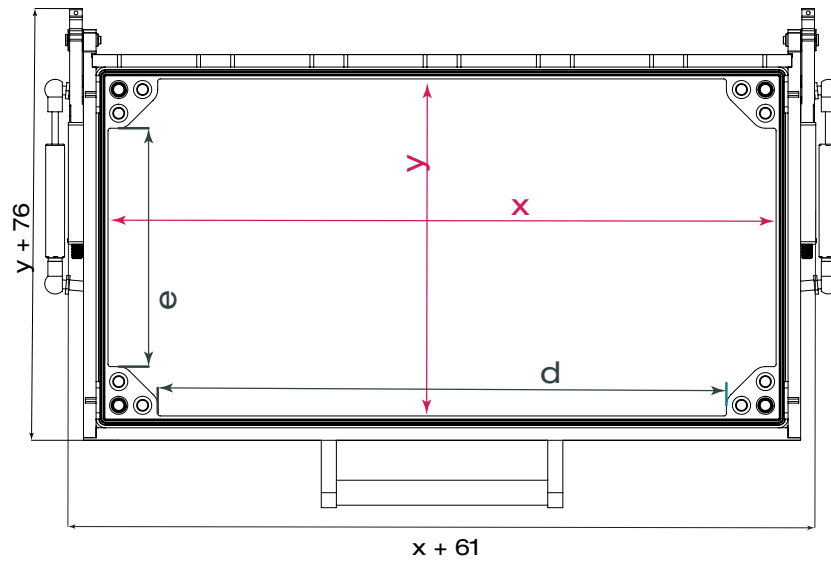

Height dimension

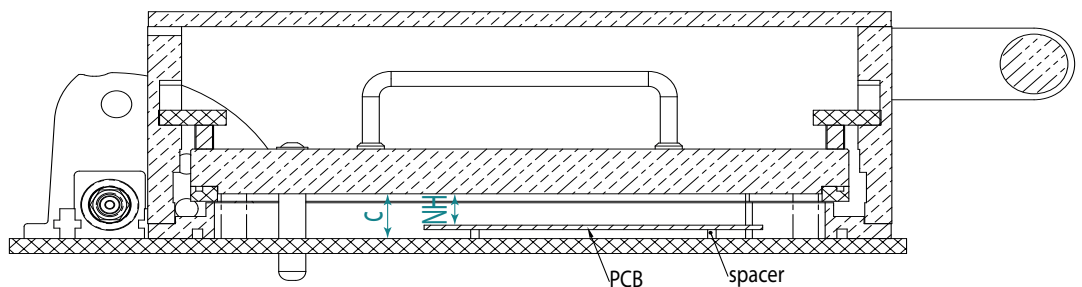



ATX HARDWARE GMBH WEST

Location Pürgen | Am Kornfeld 8 | 86932 Pürgen

Location Weil im Schönbuch | Carl-Zeiss-Straße 5/1 | 71093 Weil im Schönbuch

P +49 8196 9304-0

F +49 8196 9304-19

projekte@atx-hardware.de

www.atx-hardware.de