



VAKUUM
ADAPTERKIT

Impressum

Herausgeber:

ATX Hardware GmbH West

Am Kornfeld 8

86932 Pürgen

Telefon +49 8196 9304-0

Telefax + 49 8196 9304-19

E-Mail: projekte@atx-hardware.de

Internet: www.atx-hardware.de

INHALTSVERZEICHNIS

4	Ihr Lösungsspezialist
4	Adaptieraufbau
5	Adapterübersicht & Testsysteme
6	Vakuum Kits
7	Cobham (Aeroflex)
8	Digitaltest
10	Keysight
11	Pylon-Block
13	Seica
14	Teradyne
22	Teradyne Interfaceabdeckungen
23	Vakuum Wechselsystem
27	Vakuumhaube

IHR LÖSUNGSSPEZIALIST IM ADAPTERBAU

ATX ist Europas Marktführer in der Herstellung von Prüfadaptern für elektronische Testverfahren.
Warum auch Sie sich für einen ATX Adapter entscheiden sollten - ganz einfach:

TECHNISCHES KNOW-HOW

Unser Vertriebsteam ist technisch sehr versiert - unsere Berater werden aus dem Konstruktionsteam oder anderen technischen Abteilungen ausgewählt.

PROJEKT KNOW-HOW

Gemeinsam mit Ihnen arbeiten wir auf ein gemeinsames Ziel hin: die optimale Lösung für Ihre individuelle Prüfanforderungen zu finden und umzusetzen.

WISSENSBASIS

Unsere Mitarbeiter bringen weit mehr als 1.000 Mannjahre an Erfahrung im Adapterbau mit.

SEIT 1997

AUFBAU BAUSATZ

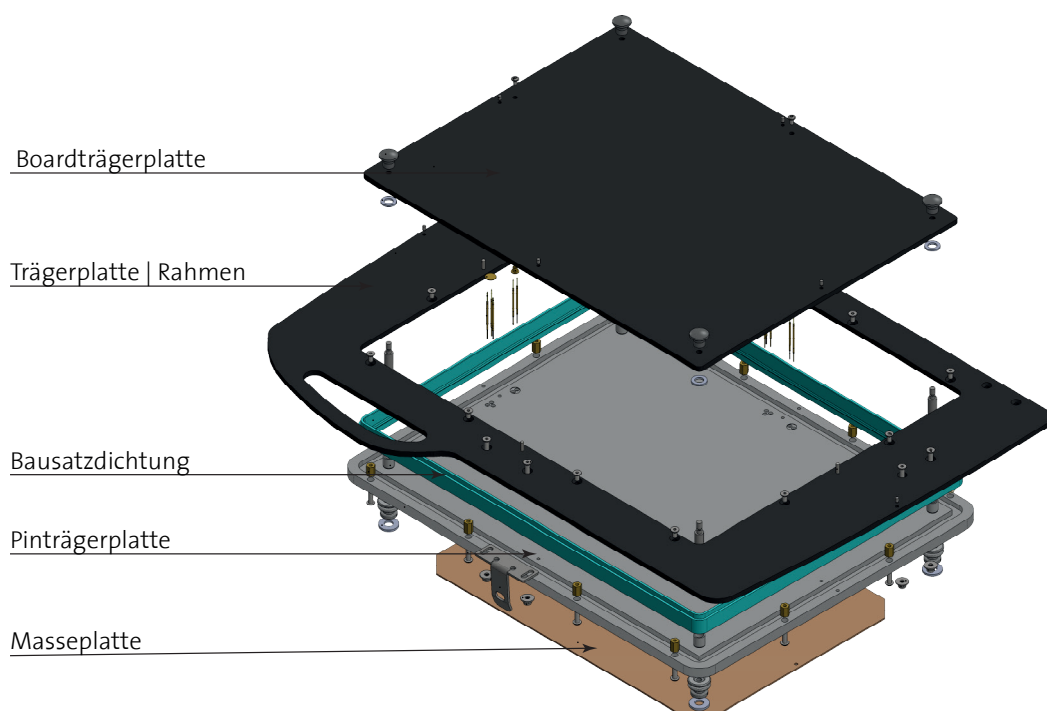

ADAPTERÜBERSICHT & TESTSYSTEME

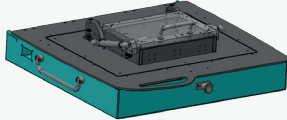
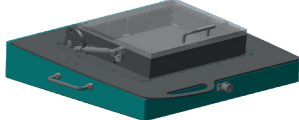
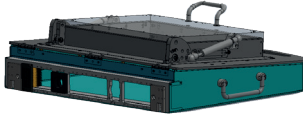
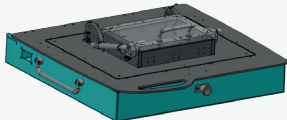
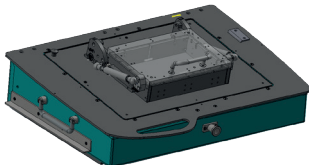
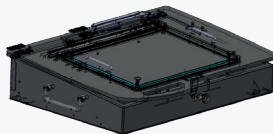
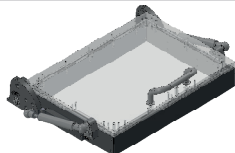
Cobham (Aeroflex)		MD 42
Digitaltest		MTS 210 MTS 300
Keysight		HP3070 small HP3070 large
Pylon-Block		Pylon 12-Fach Pylon 16-Fach
Seica		Compact V
Teradyne		<p>Teststation TS 12X (Genrad228X) 15 Slot 128 Interface max. 1536 D/S 18 Slot 128 Interface max. 1920 D/S 23 Slot 128 Interface max. 2560 D/S 33 Slot 128 Interface max. 3840 D/S</p> <p>Teststation LH 19 Slot Interface max. 4096 D/S</p> <p>Teststation Multi-Site TSA/TSO/TSI 5 Slot 256 Interface max. 1280 D/S 5 Slot HD Interface max. 2560 D/S</p> <p>Teststation Teradyne Spectrum TSSE88xx-1280 TSSE88xx-2560</p> <p>Interface Abdeckung</p>
Wechselsystem		<p>WK1 + WK2 Für Digitaltest MTS-300 Für Teradyne TS12X (Genrad228X) Für Pylon 12-Fach</p> <p>WK3 + WK4 Für Digitaltest MTS-300 Für Teradyne TS12X (Genrad228X)</p>
Vakuumbaube		Einseitige Haube Standard Beidseitige Haube Top Access

VAKUUM KITS

STELLEN SIE IHR PRODUKT NACH IHREN BEDÜRFNISSEN ZUSAMMEN

Bei uns finden Sie leistungsfähige Adaptermodelle, abgestimmt auf Ihre individuelle Prüf- und Testumgebung. Alle Adapterkits werden ohne Interface und Haube geliefert. Diese Positionen müssen expliziert dazu bestellt werden.

LIEFERUMFANG VAKUUM-KIT

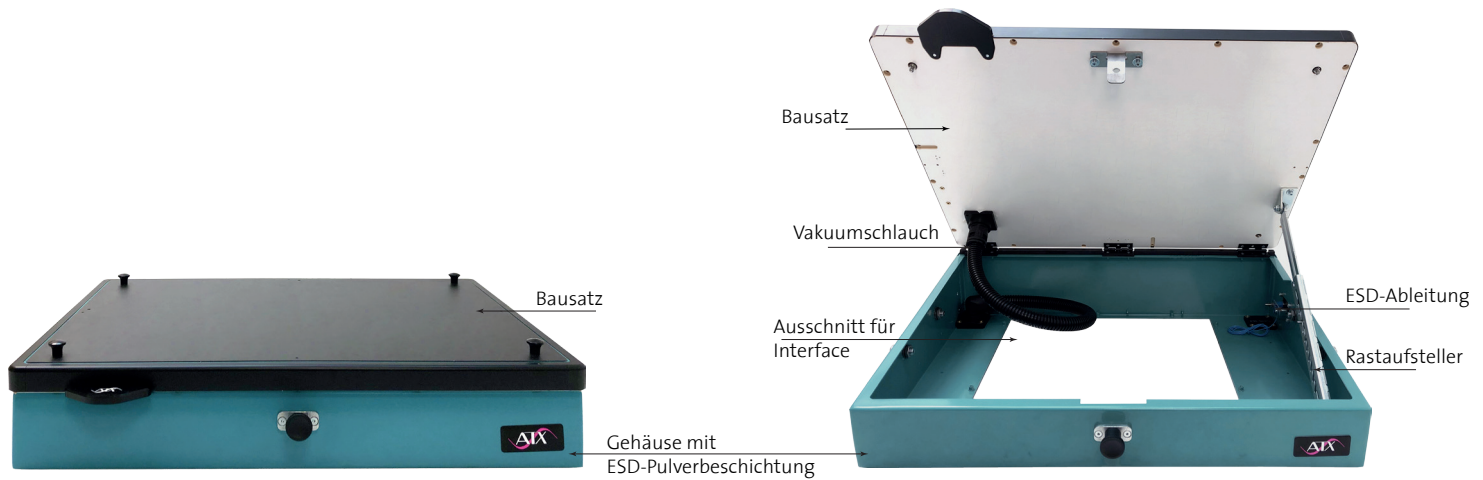

COBHAM (AEROFLEX)

TESTSTATION MD42

Interface

Bestellnummer	Bezeichnung
101435	IF-MD42 Interface unbestückt MD42 Znr E07-00018

Interfacekontakt



Interfacepin | KT-158 02 Plan

Bestellnummer

670049

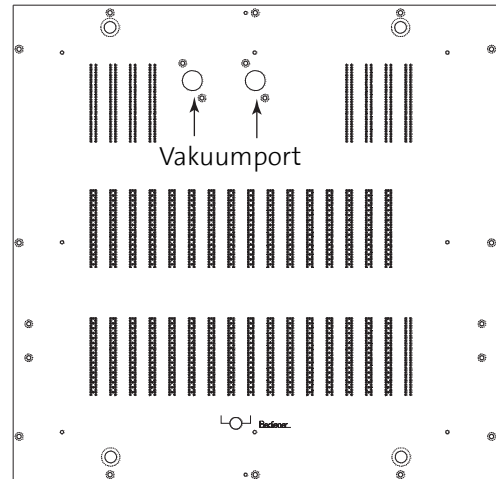

Adapterkit ohne Interface

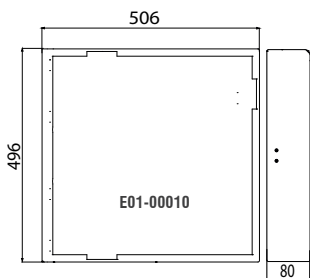
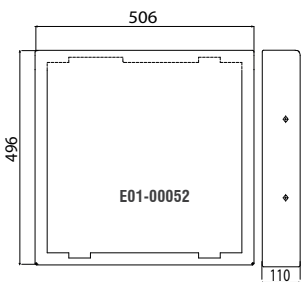
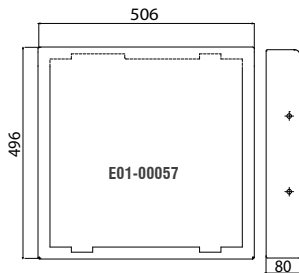

Bestellnummer	Bezeichnung
106004	KIT-V-2-Aeroflex-MD42-single Vakuumadapter single ohne Interface Gehäuse E01-00057 Bausatz x 415 y 320 - B50-00025

106005	KIT-V-2-Aeroflex-MD42-single-hoch Vakuumadapter single ohne Interface Hohes Gehäuse E01-00052 Bausatz x 415 y 320 - B50-00025
--------	--

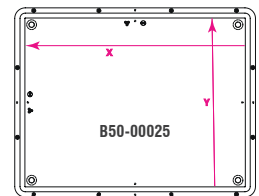

Bestellnummer	Bezeichnung
106002	KIT-V-2-Aeroflex-MD42-links Vakuumadapter single ohne Interface Gehäuse E01-00010 links öffnend Bausatz x 320 y 415 - B50-00053

106003	KIT-V-2-Aeroflex-MD42-links-quer Vakuumadapter single ohne Interface Hohes Gehäuse E01-00010 links öffnend Bausatz x 4415 y 320 - B50-00054
--------	--

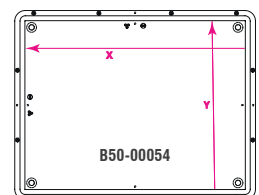
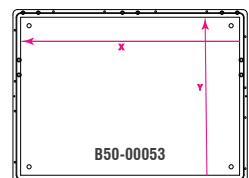

TESTSTATION MTS 210

Interface

Bestellnummer	Bezeichnung
262694	IF-MTS210 Interface unbestückt MTS210 Znr E07-00004

Interfacekontakt



Interfacepin großer Innenkonus | KT-158

Bestellnummer

670054

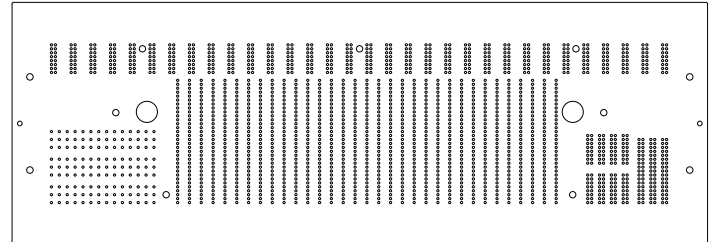

Adapterkit ohne Interface

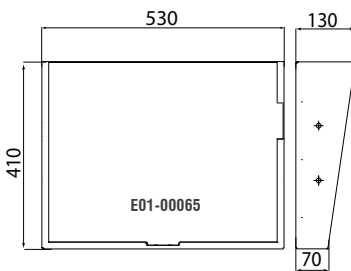

Bestellnummer	Bezeichnung
100300	KIT-V-3-Digitaltest-MTS210 Vakuuadapter single ohne Interface Gehäuse E01-00065 Bausatz x 415 y 320 - B50-00031

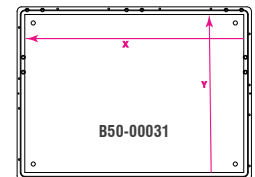

TESTSTATION MTS 300

Interface

Bestellnummer	Bezeichnung
262350	IF-MTS300 Interface unbestückt MTS300 Znr E07-00139

Interfacekontakt



Interfacepin großer Innenkonus | KT-158

Bestellnummer
670054

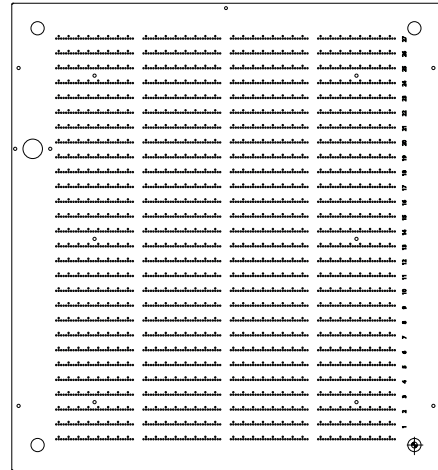

Adapterkit ohne Interface

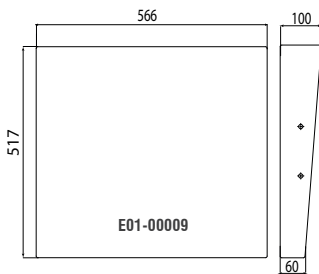

Bestellnummer	Bezeichnung
106040	KIT-V-3-Digitaltest-MTS300-single Vakuuadapter single ohne Interface Standardgehäuse E01-00009 Bausatz x 542 y 480 - B50-00099

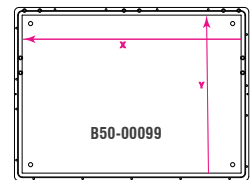

106041	KIT-V-3-Digitaltest-MTS300-doppel Vakuuadapter Doppelkammer ohne Interface Standardgehäuse E01-00009 Doppelkammer x 245 y 385 - B50-00030
--------	--

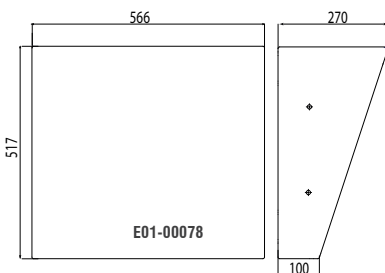
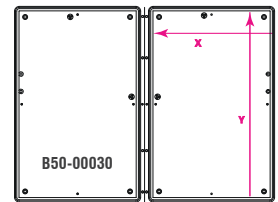

Bestellnummer	Bezeichnung
106006	KIT-V-3-Digitaltest-MTS300-single-hoch Vakuuadapter single ohne Interface Standardgehäuse E01-00078 Bausatz x 542 y 480 - B50-00099

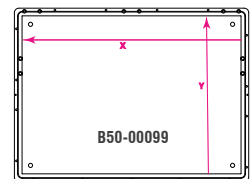

106043	KIT-V-3-Digitaltest-MTS300-doppel-hoch Vakuuadapter Doppelkammer ohne Interface Standardgehäuse E01-00078 Doppelkammer x 245 y 385 - B50-00030
--------	---

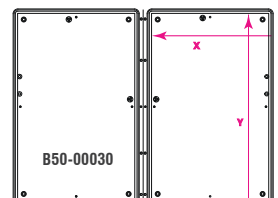

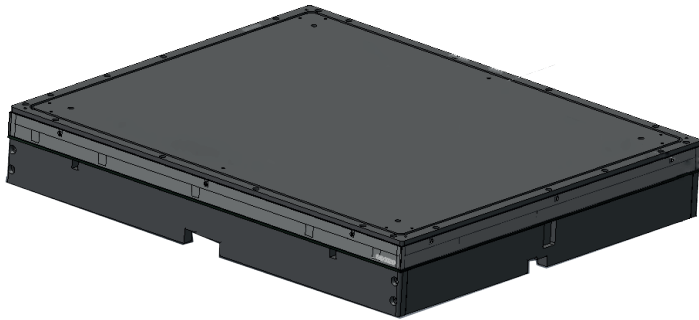

Interfacekontakte



HP-Interfacepin
Original Agilent Perso-Pin

Bestellnummer
670030

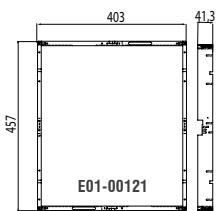

Adapterkit inklusive Alignment Plate

Bestellnummer	Bezeichnung
100202	KIT-V-4-Keysight-HP3070-small Vakuumadapter single Rahmen Alu E01-000121 Bausatz x 377 y 431 - B50-00094

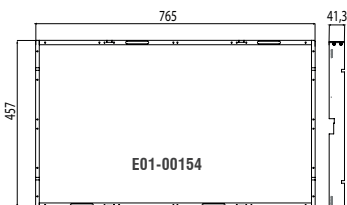
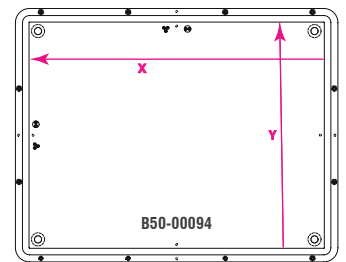

Bestellnummer	Bezeichnung
100200	KIT-V-4-Keysight-HP3070-large Vakuumadapter single Rahmen Alu E01-000154 Bausatz x 740 y 432 - B50-00101

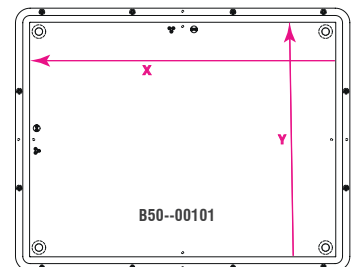

PYLON-BLOCK

12-FACH UND 16-FACH

Interface

Pylonblöcke 12-Fach und 16-Fach



Wir bieten Ihnen eine große Auswahl an verschiedenen Interfaceblöcken. Diese finden Sie in unserer Broschüre über [Interfaceblöcke](#).

U-Kanal 12-Fach-Kit Znr. E07-00308 **U-Kanal 16-Fach-Kit Znr. E07-00070**

Beide U-Kanäle werden standardmäßig nur mit einem Vakuumport geliefert. Werden mehrere Vakuumports benötigt, teilen Sie uns dies bitte auf Ihrer Bestellung mit.

Adapterkit inklusive U-Kanal ohne Interfaceblöcke

U-Kanal 12-Fach Kit Znr. E07-00308

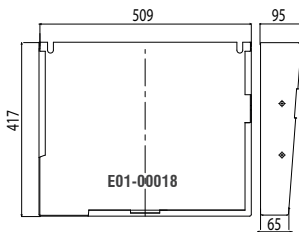
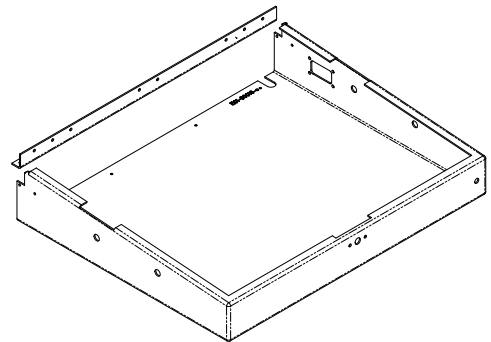
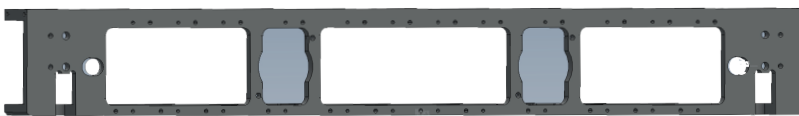

Bestellnummer	Bezeichnung
100400	KIT-V-5-Pylon-Block-12Fach-single Vakuuadapter single inkl. U-Kanal und 1 Vakuumport, ohne IF-Blöcke Gehäuse E01-00018 Bausatz x 485 y 380 - B50-00095
106008	KIT-V-5-Pylon-Block-12Fach-doppel Vakuuadapter Doppelkammer inkl. U-Kanal und 2 Vakuumport ohne IF-Blöcke Gehäuse E01-00018 Doppelkammer x 242,5 y 380 - B50-00103

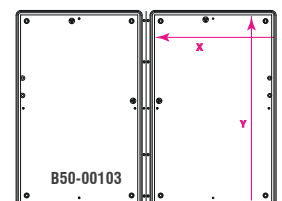
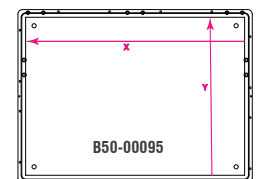

PYLON-BLOCK

12-FACH UND 16-FACH

Adapterkit inklusive U-Kanal ohne Interfaceblöcke

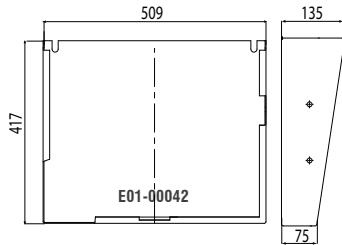

Bestellnummer	Bezeichnung
106009	KIT-V-5-Pylon-Block-12Fach-single-hoch Vakuumadapter single inkl. U-Kanal und 1 Vakuumport, ohne IF-Blöcke Gehäuse E01-00042 Bausatz x 485 y 380 - B50-00095
106010	KIT-V-5-Pylon-Block-12Fach-doppel-hoch Vakuumadapter Doppelkammer inkl. U-Kanal und 2 Vakuumport, ohne IF-Blöcke Gehäuse E01-00042 Doppelkammer x 242,5 y 380 - B50-00103

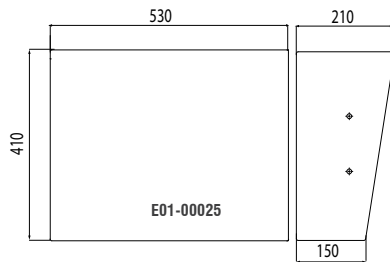
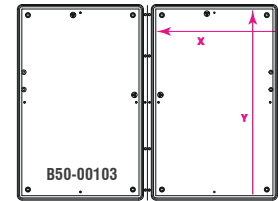
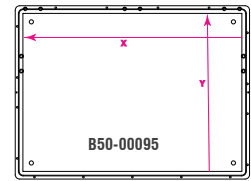

Bestellnummer	Bezeichnung
106011	KIT-V-5-Pylon-Block-12Fach-single-exhoch Vakuumadapter single inkl. U-Kanal und 1 Vakuumport, ohne IF-Blöcke Gehäuse E01-00025 Bausatz x 515 y 385 - B50-00098
106012	KIT-V-5-Pylon-Block-12Fach-doppel-exhoch Vakuumadapter Doppelkammer inkl. U-Kanal und 2 Vakuumport, ohne IF-Blöcke Gehäuse E01-00025 Doppelkammer x 265 y 365 - B50-00049

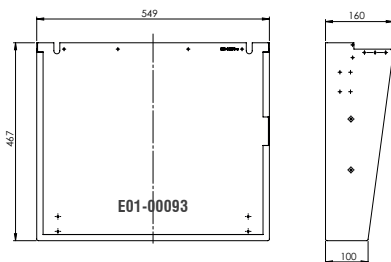
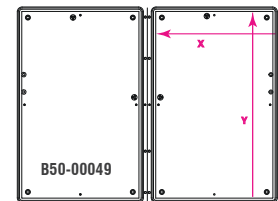
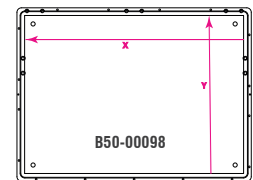

Bestellnummer	Bezeichnung
106050	KIT-V-5-Pylon-Block-12Fach-single-hoch Vakuumadapter single inkl. U-Kanal und 1 Vakuumport, ohne IF-Blöcke Gehäuse E01-00093 Bausatz x 580 y 525 - B50-00093

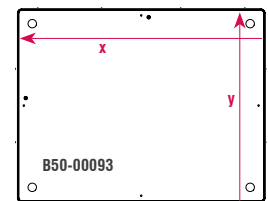

U-Kanal 16-Fach Kit Znr. E07-00070

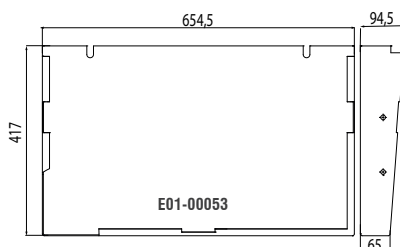
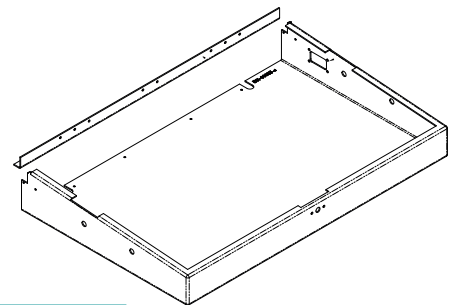

Bestellnummer	Bezeichnung
100469	KIT-V-5-Pylon-Block-16 Fach Vakuumadapter single inkl. U-Kanal und 1 Vakuumport, ohne IF-Blöcke Gehäuse E01-00053 Bausatz x 630,5 y 380 - B50-00097

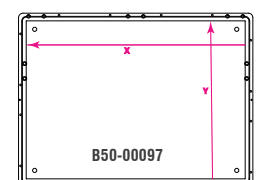

TESTSTATION COMPACT-V

Seica-PM-Y1801330

Interface

Bestellnummer	Bezeichnung
584007	IF-Seica-PM Interface unbestückt Znr B10-00015 inkl. RFID-Chip

Interfacekontakt | Zubehör



Interfacepin | KT-158 02
Plan

Bestellnummer
670049



RFID Chip Transponder
RTP-0301-020

Bestellnummer
549169

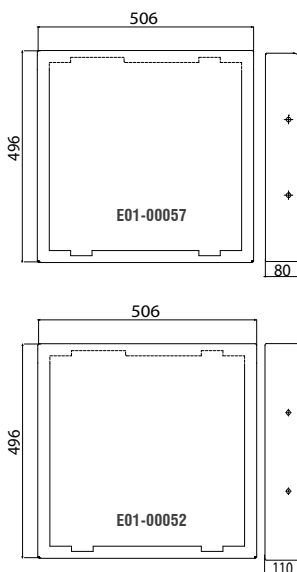
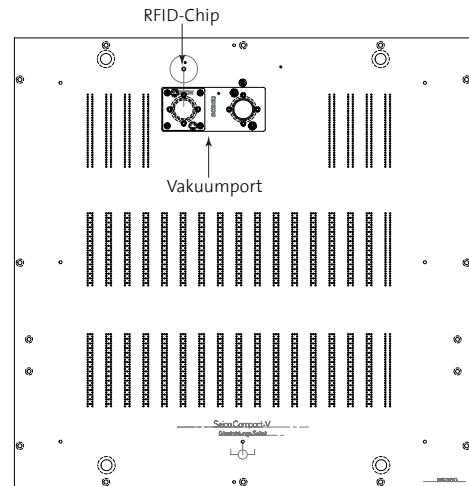

Adapterkit ohne Interface

Bestellnummer	Bezeichnung
106014	KIT-V-6-Seica-PM-Y1801330-single Vakuumadapter single ohne Interface Gehäuse E01-00057 Bausatz x 415 y 320 - B50-00025
106015	KIT-V-6-Seica-PM-Y1801330-single-hoch Vakuumadapter single ohne Interface Hohes Gehäuse E01-00052 Bausatz x 415 y 320 - B50-00025

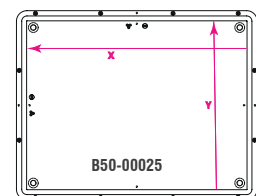

TESTSTATION TS 12X (GENRAD228X) UND LH | INTERFACE 15 SLOT UND 18 SLOT

15 Slot 128 Interface max. 1536 D/S

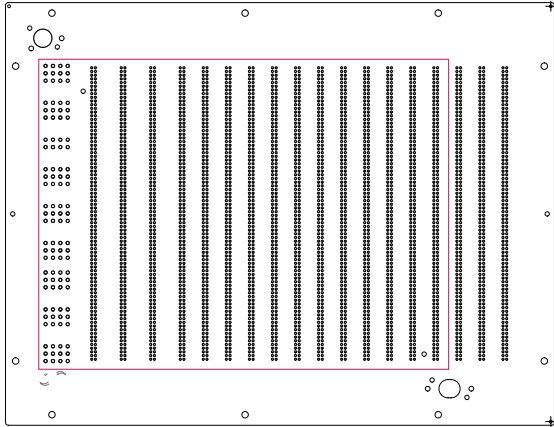

Interface

Bestellnummer	Bezeichnung
584003	IF-TER-GR228x-15 Interface unbestückt 15Slot Znr E07-00265
101100	IF-TER-GR228x-15-1 Interface teilbestückt mit 512 D/S (Slot 0 und 1 unbestückt)
101102	IF-TER-GR228x-15-2 Interface teilbestückt mit 1024 D/S (Slot 0 und 1 unbestückt)
101104	IF-TER-GR228x-15-3 Interface vollbestückt mit 1536 D/S (Slot 0 und 1 unbestückt)

15 Slot 128 Interface max. 1536 D/S

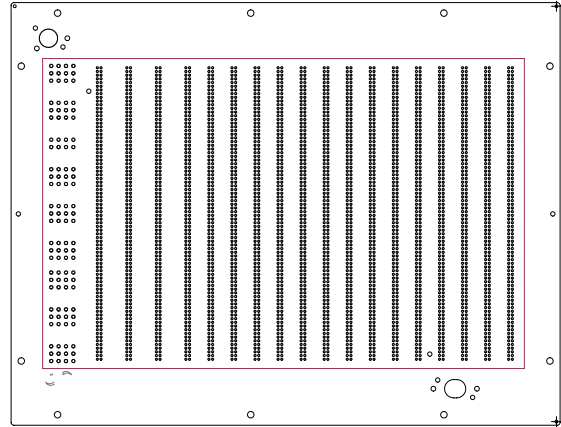

Interface

Bestellnummer	Bezeichnung
584004	IF-TER-GR228x-18 Interface unbestückt 18Slot Znr E07-00266
101106	IF-TER-GR228x-18-1 Interface vollbestückt mit 1920 D/S (Slot 0 und 1 unbestückt)

Interfacekontakte



Interfacepin
KT-158 02 Plan

Bestellnummer
670049



Powersip Löt GPP

Bestellnummer
699003



Powersip WireWrap
FK 521

Bestellnummer
699004

Adapterkit | Liftschienen

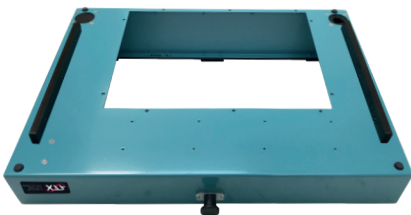

Schnittstellenschutz
Znr. E90-50123

Bestellnummer
263331

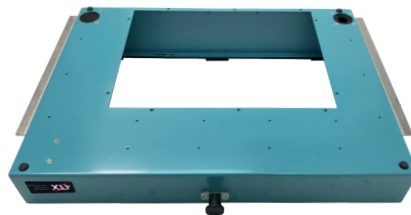

Liftschiene
Znr. E01-00075

Bestellnummer
304116



Schutzleiste Winkel
Znr. E01-00086 | E01-00087

Bestellnummer
304104 304125

TESTSTATION TS 12X (GENRAD228X) UND LH | INTERFACE 15 SLOT UND 18 SLOT

Adapterkit ohne Interface

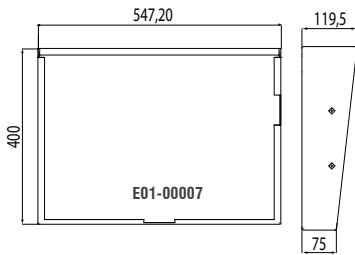

Bestellnummer	Bezeichnung
100118	KIT-V-1-Teradyne-TS12X IF15+18 Slot-single Vakuumadapter single ohne Interface Gehäuse E01-00007 Bausatz x 523,2 y 380 - B50-00096
106019	KIT-V-1-Teradyne-TS12X-IF 15+18 Slot-doppel Vakuumadapter Doppelkammer ohne Interface Gehäuse E01-00007 Doppelkammer x 246,6 y 380 - B50-00106

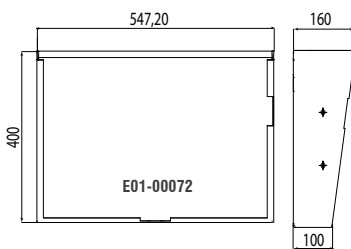
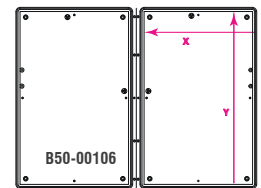
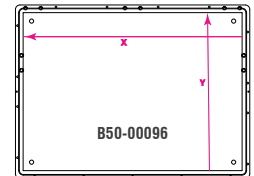

Bestellnummer	Bezeichnung
106020	KIT-V-1-Teradyne-TS12x-IF 15+18 Slot-single-hoch Vakuumadapter single ohne Interface Hohes Gehäuse E01-00072 Bausatz x 523,2 y 380 - B50-00096
106021	KIT-V-1-Teradyne-TS12X-IF 15+18 Slot-doppel-hoch Vakuumadapter Doppelkammer ohne Interface Hohes Gehäuse E01-00072 Doppelkammer x 246,6 y 380 - B50-00106

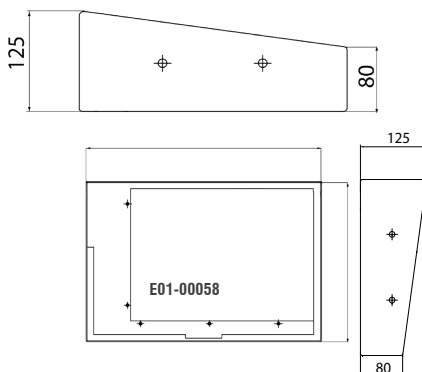
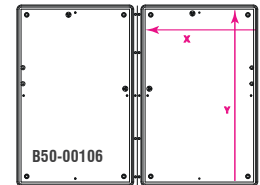
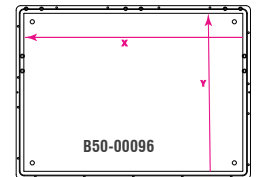

Bestellnummer	Bezeichnung
100361	KIT-V-1-Teradyne-TS12x-IF 15+18 Slot-single-hoch Vakuumadapter single ohne Interface Hohes Gehäuse E01-00058 Bausatz x 430 y 299 - B50-00125

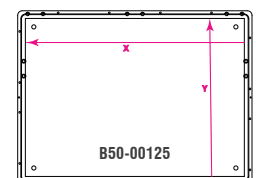

TESTSTATION TS 12X (GENRAD228X) UND LH | INTERFACE 23 SLOT

23 Slot 128 Interface max. 1536 D/S

Interface

Bestellnummer	Bezeichnung
584001	IF-TER-GR228x-23 Interface unbestückt 23 Slot Znr E07-000267
101108	IF-TER-GR228x-23-1 Interface teilbestückt mit 2048 D/S (Slot 0 und 1 unbestückt)
110110	IF-TER-GR228x-23-2 Interface vollbestückt mit 2560 D/S (Slot 0 und 1 unbestückt)

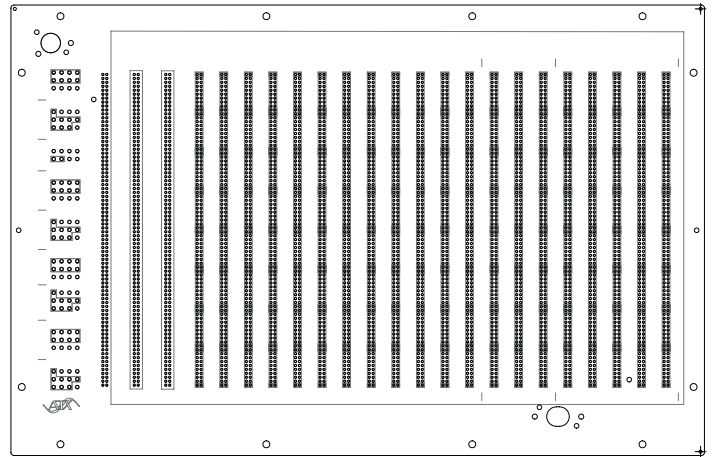

Interfacekontakte



Interfacepin
KT-158 02 Plan



Powersip Löt GPP



Powersip WireWrap
FK 521

Bestellnummer	Bestellnummer	Bestellnummer
670049	699003	699004

Adapterkit ohne Interface

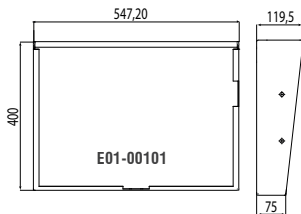

Bestellnummer	Bezeichnung
100100	KIT-V-1-Teradyne-TS12X-IF 23 Slot-single Vakuuadapter GR228x single ohne Interface Gehäuse E01-00101 Bausatz x 523,2 y 380 - B50-00096

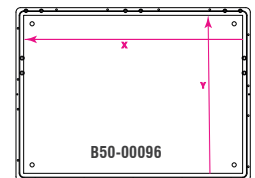

106022	KIT-V-1-Teradyne-TS12X-IF 23 Slot-doppel Vakuuadapter GR228x doppel ohne Interface Gehäuse E01-00101 Doppelkammer x 246,6 y 380 - B50-00106
--------	---

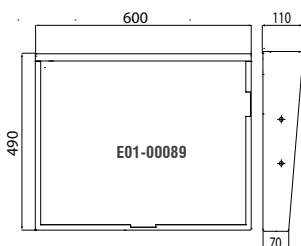
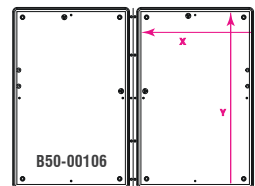

Bestellnummer	Bezeichnung
100122	KIT-V-1-Teradyne-TS12X-IF 23 Slot-single-wide Vakuuadapter GR228x single ohne Interface Gehäuse E01-00089 Bausatz x 615 y 430 - B50-00087

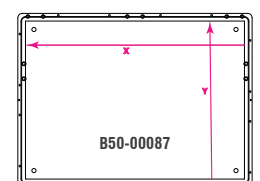

TESTSTATION TS LX (GENRAD 228X) | INTERFACE 33 SLOT

33 Slot 128 Interface max. 3840 D/S

Interface

Bestellnummer	Bezeichnung
584005	IF-TER-GR228x-33 Interface unbestückt 33 Slot Znr E07-00270
580010	IF-TER-GR228x-33-1 Interface vollbestückt mit 3840 D/S (Slot 0 und 1 unbestückt)
1584006	IF-TER-Gr228x-DUO Interface unbestückt 33 Slot DUO Znr E07-00264

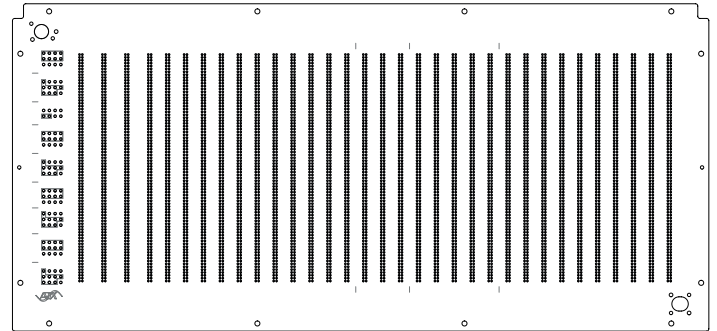

Interfacekontakte



Interfacepin
KT-158 02 Plan



Powersip Löt GPP



Powersip WireWrap
FK 521

Bestellnummer
670049

Bestellnummer
699003

Bestellnummer
699004

Adapterkit ohne Interface

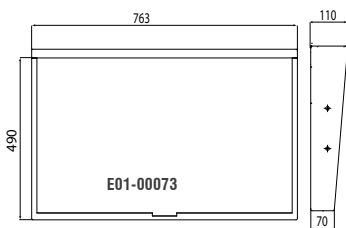

Bestellnummer	Bezeichnung
100102	KIT-V-1-Teradyne-TS12x (Genrad 228x)-IF 33 Slot Vakuuadapter single ohne Interface Gehäuse E01-00073 Bausatz x 739 y 465 - B50-00124

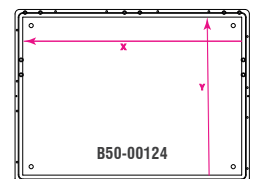

TESTSTATION LH | INTERFACE 19 SLOT

19 Slot Interface max. 4096 D/S

Interface

Bestellnummer	Bezeichnung
304133	IF-TER-LH-19Slot Interface unbestückt 19 Slot Znr E07-00024

Interfacekontakte



Interfacepin
KT-158 02 Plan



Powersip Löt GPP



Powersip WireWrap
FK 521

Bestellnummer
670049

Bestellnummer
699003

Bestellnummer
699004

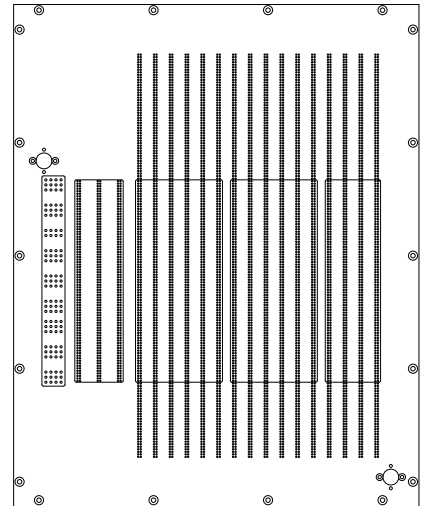

Adapterkit ohne Interface

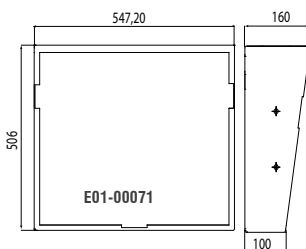

Bestellnummer	Bezeichnung
106047	KIT-V-1-Teradyne-LH-IF 19 Slot-single Vakuuadapter single ohne Interface Gehäuse E01-00071 Bausatz x 523,2 y 380 - B50-00096
106018	KIT-V-1-Teradyne-LH-IF 19 Slot-doppelt Vakuuadapter Doppelkammer ohne Interface Gehäuse E01-00071 Doppelkammer x 246,6 y 380 - B50-00106

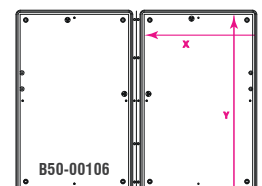
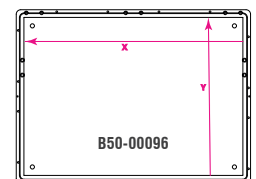

TESTSTATION MULTI-SITE TSA/TSO/TSI

5 Slot 256 Interface max. 1280 D/S

5 Slot 512 HD Interface max. 2560 D/S

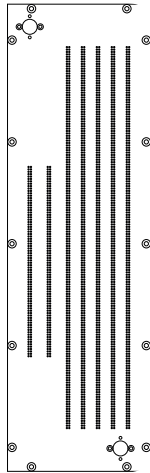

Interface

Interfacekontakt



Interfacepin | KT-158 02 Plan

Bestellnummer

670049

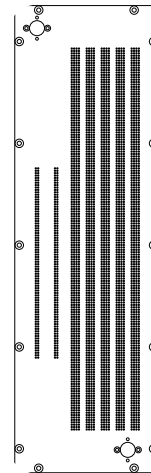

Interface

Bestellnummer	Bezeichnung
581015	IF-TER-TSA/O/H-256 Interface unbestückt 5 Slot Znr B10-00001
581008	IF-TER-TSA/O/H-256 voll Interface vollbestückt mit 1280 D/S

Bestellnummer	Bezeichnung
581016	IF-TER-TSA/O/H/-HD Interface unbestückt 5 Slot Znr B10-00008
581007	IF-TER-TSA/O/H/HD voll Interface vollbestückt mit 2560 D/S

Adapterkit ohne Interface

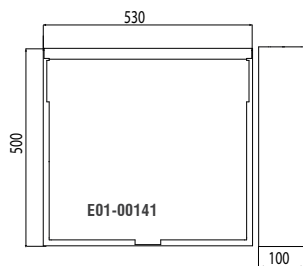

Bestellnummer	Bezeichnung
100225	KIT-V-1-Teradyne-TSO-TSA-1-single-small Vakuumadapter single ohne Interface Gehäuse E01-00141 Bausatz x 506 y 476 - B50-00116

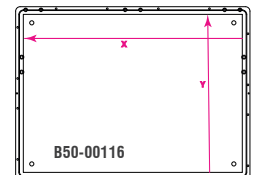

106024	KIT-V-1-Teradyne-TSO-TSA-2-doppel Vakuumadapter Doppelkammer ohne Interface Gehäuse E01-00141 Doppelkammer x 238 y 380 - B50-00117
--------	--

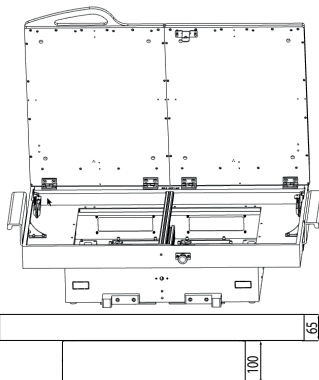
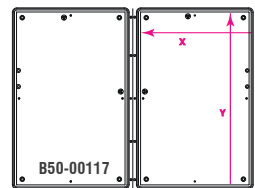

Bestellnummer	Bezeichnung
100226	KIT-V-1-Teradyne-TSO-TSA-3-single-wide Vakuumadapter single ohne Interface Gehäuse E01-00140 + E01-00141 Bausatz x 736 y 380 - B50-00120

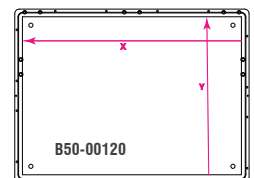

100227	KIT-V-1-Teradyne-TSO-TSA-4-doppel-wide Vakuumadapter single ohne Interface Gehäuse E01-00140 + E01-00141 Doppelkammer x 353 y 476 - B50-00121
--------	---

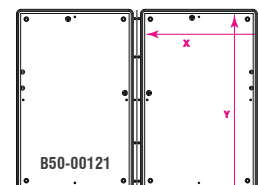

TESTSTATION SPECTRUM | TSSE88XX-1280

TSSE88xx-1280

Interface

Bestellnummer	Bezeichnung
581013	IF-TER-TSSE88xx-1280 Interface unbestückt TSSE88xx-1280 Znr E07-00006
580012	IF-TER-TSSE88xx-1280 voll Interface vollbestückt mit 1280 D/S (Slot 0 und 1 unbestückt)

Interfacekontakte



Interfacepin
KT-158 02 Plan

Bestellnummer

670049



Powersip WireWrap
FK 521

Bestellnummer

699004

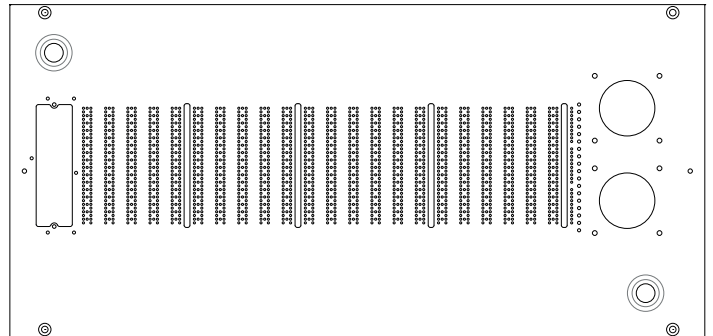

Adapterkit ohne Interface

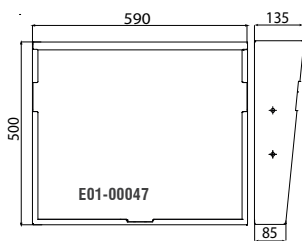

Bestellnummer	Bezeichnung
106038	KIT-V-1-Teradyne-Spectrum (TSSE88xx-1280)-single Vakuumadapter single ohne Interface Gehäuse E01-00047 Bausatz x 566 y 480 - B50-00100
1106037	KIT-V-1-Teradyne-Spectrum (TSSE88xx-1280)-doppel Vakuumadapter doppel ohne Interface Gehäuse E01-00047 Doppelkammer x 320 y 415 - B50-00071

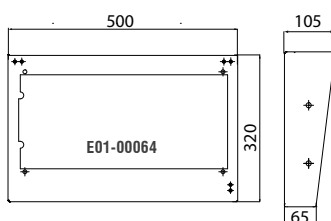
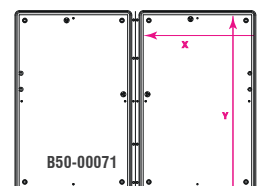
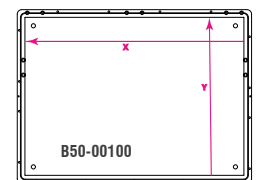

Bestellnummer	Bezeichnung
106039	KIT-V-1-Teradyne-Spectrum (TSSE8xx-1280)-small Vakuumadapter single ohne Interface Gehäuse E01-00064 Bausatz x 365 y 265 - B50-00084

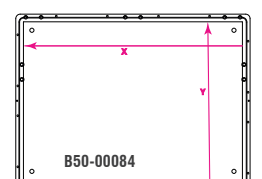

TESTSTATION SPECTRUM | TSSE88XX-2560

TSSE88xx-2560

Interface

Bestellnummer	Bezeichnung
581014	IF-TER-TSSE88xx-2560 Interface unbestückt TSSE88x-2560 Znr E07-00007
580013	IF-TER-TSSE88xx-2560 voll Interface vollbestückt mit 2560 D/S (Slot 0 und 1 unbestückt)

Interfacekontakte



Interfacepin
KT-158 02 Plan

Bestellnummer

670049



Powersip WireWrap
FK 521

Bestellnummer

699004

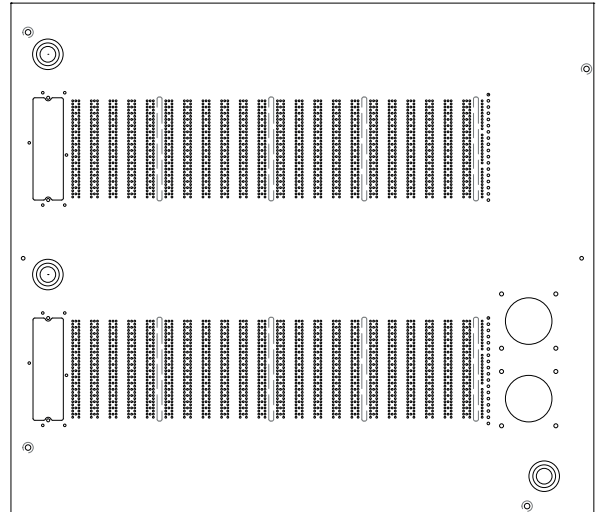

Adapterkit ohne Interface

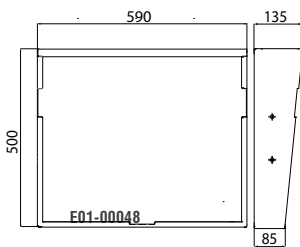

Bestellnummer	Bezeichnung
100119	KIT-V-1-Teradyne-Spectrum (TSSE88xx.2560)-single Vakuuadapter single ohne Interface Gehäuse E01-00048 Bausatz x 566 y 480 - B50-00100
106025	KIT-V-1-Teradyne-Spectrum (TSSE88xx-2560)-doppel Vakuuadapter doppel ohne Interface Gehäuse E01-00048 Doppelkammer x 320 y 415 - B50-00071

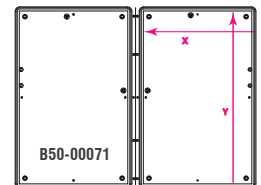
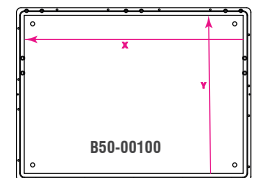

INTERFACEABDECKUNGEN

Testsystem LH

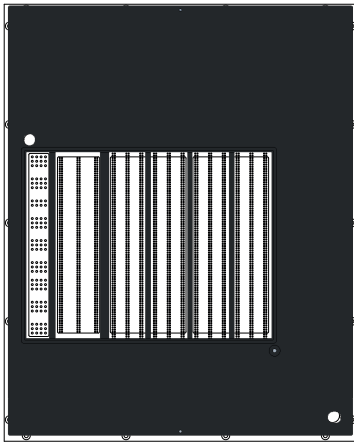

Bestellnummer	Bezeichnung
101433	Adapter Interface 19 Slot 256 Pin Karte Slot- Pinanzahl Genrad 8x 128 Pin 0-15 Slot 1536 D/S Znr. E07-00272

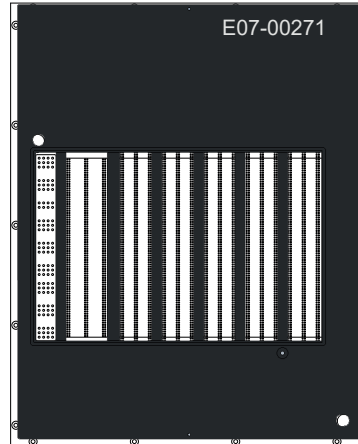

Bestellnummer	Bezeichnung
101151	Adapter Interface 19 Slot 256 Pin Karte Slot- Pinanzahl Genrad 8x 128 Pin 0-18 Slot 1920 D/S Znr. E07-00271

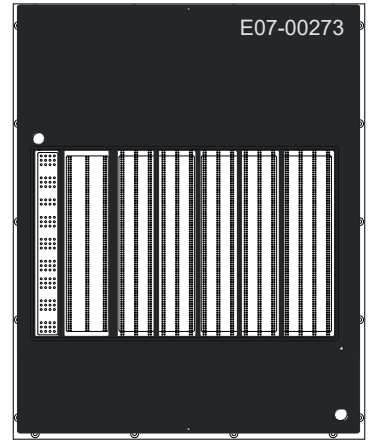

Bestellnummer	Bezeichnung
101153	Adapter Interface 19 Slot 256 Pin Karte Slot- Pinanzahl Genrad 8x 128 Pin 0-19 Slot 2048D/S Znr. E07-00273

Testsystem LH

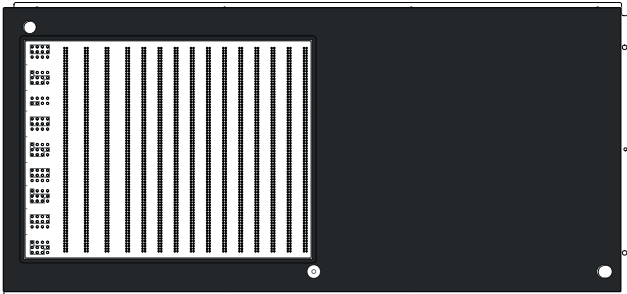

Bestellnummer	Bezeichnung
101150	Adapter Interface 33 Slot 128 Pin Karte Slot- Pinanzahl Genrad 8x 128 Pin 0-15 Slot 1536 D/S Znr. E07-00133

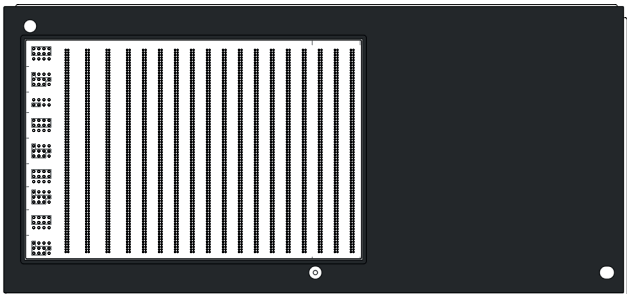

Bestellnummer	Bezeichnung
101152	Adapter Interface 33 Slot 128 Pin Karte Slot- Pinanzahl Genrad 8x 128 Pin 0-18 Slot 1920 D/S Znr. E07-00134

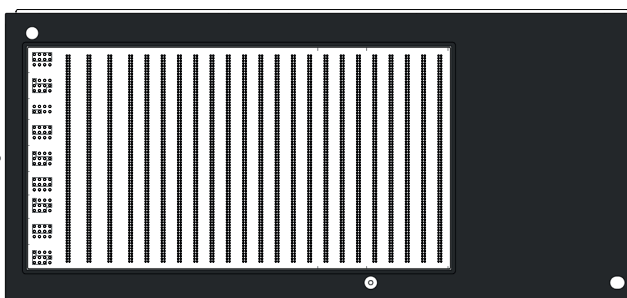

Bestellnummer	Bezeichnung
101154	Adapter Interface 33 Slot 128 Pin Karte Slot- Pinanzahl Genrad 8x 128 Pin 0-23 Slot 12560 D/S Znr. E07-00135

VAKUUM WECHSELSYSTEM

WK2

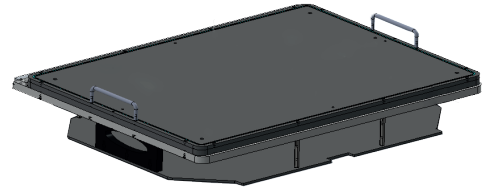
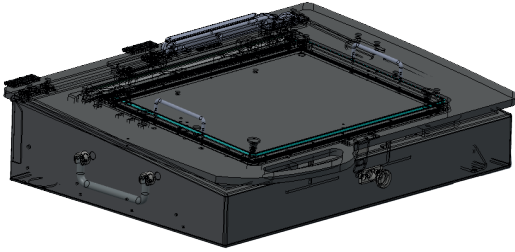

Standard

Bestellnummer	Bezeichnung
100402	WK1 Wechselkassette für 840 Übergabekontakte

Das Vakuum Wechselsystem von ATX ist Testsystem unabhängig und kann daher auf alle Systeme angepasst werden.

- Aeroflex
- Digitaltest
- Seica
- Pylon-Block
- Teradyne

Interfacekontakte Grundgerät



Hülse 100mil 5mm
H502WW

Bestellnummer
681002



Pin Waffel 100mil
F562 06B 190 G 100

Bestellnummer
630001

Interfacekontakte Wechselkassette



Interfacepin plan WW
I-G1S1

Bestellnummer
670001

Bausatz Wechselkassette

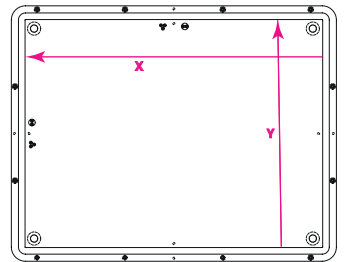

Ausbau auf Digitaltest

Bestellnummer	Bezeichnung
262350	IF-MTS-300 Interface unbestückt MTS300 Znr. E07-00139

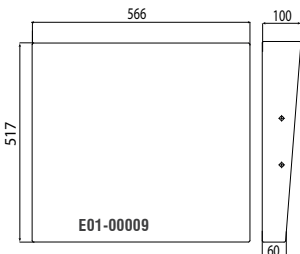

Bestellnummer	Bezeichnung
106026	KIT-V-3-Digitaltest-WK2-MTS300 Grundgerät WK2 ohne Wechselkassette WK1 Gehäuse E01-00009 Bausatz WK1 x 365 y 265 - B50-00041

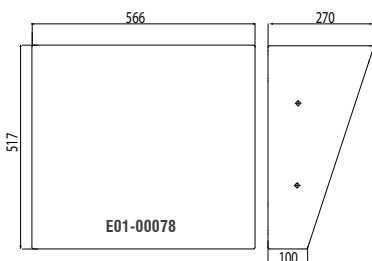
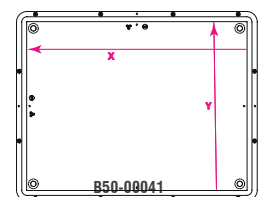

106027	KIT-V-3-Digitaltest-WK2-MTS300-hoch Grundgerät WK2 ohne Wechselkassette WK1 Hohes Gehäuse E01-00078 Bausatz WK1 x 365 y 265 - B50-00041
--------	---

VAKUUM WECHSELSYSTEM

WK2

Ausbau auf Teradyne

Bestellnummer	Bezeichnung
584003	IF-TER-GR228X-15 Interface unbestückt 15 Slot Znr. E07-00265

Bestellnummer	Bezeichnung
584004	IF-TER-GR228X-18 Interface unbestückt 18 Slot Znr. E07-00266

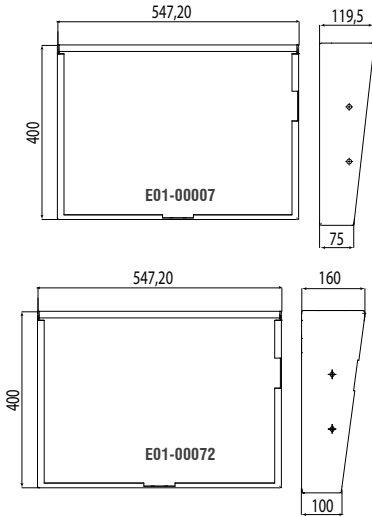

Bestellnummer	Bezeichnung
106028	KIT-V-1-Teradyne-WK2-TS12x-IF 15+ 18 Slot Grundgerät WK2 ohne Wechselkassette WK1 Gehäuse E01-00007 Bausatz WK1 x 365 y 265 - B50-00041
106029	KIT-V-1-Teradyne-WK2-TS12x-IF 15+ 18 Slot-hoch Grundgerät WK2 ohne Wechselkassette WK1 Hohes Gehäuse E01-00072 Bausatz WK1 x 365 y 265 - B50-00041

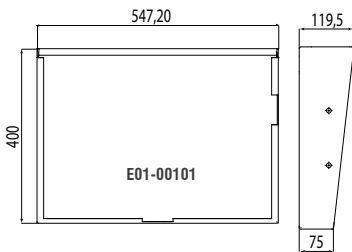
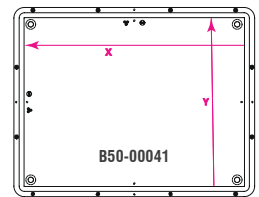

Bestellnummer	Bezeichnung
106030	KIT-V-1-Teradyne-WK2-TS12X (GR228X)-IF 23 Slot Grundgerät WK2 ohne Wechselkassette WK1 Gehäuse E01-00101 Bausatz WK1 x 365 y 265 - B50-00041

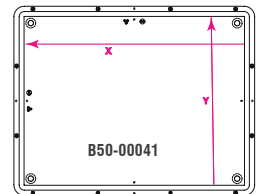

Ausbau auf Teradyne

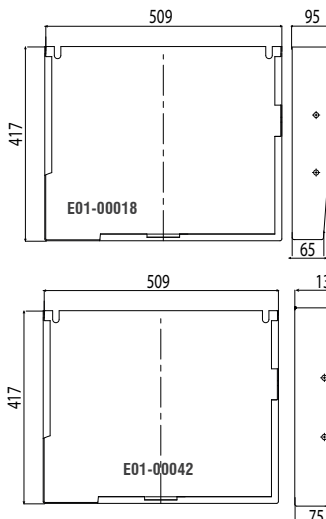

Bestellnummer	Bezeichnung
106031	KIT-V-5-Pylon-Block-12Fach-WK2 Grundgerät WK2 ohne Wechselkassette WK1 inkl. U-Kanal 12-Fach gehäuse E01-00018 Bausatz x 365 y 265 - B50-00041
106032	KIT-V-5-Pylon-Block-12Fach-Wk2-hoch Grundgerät WK2 ohne Wechselkassette WK1 inkl. U-Kanal 12-Fach Hohes Gehäuse E01-00042 Bausatz Wk1 x 365 y 265 - B50-00041

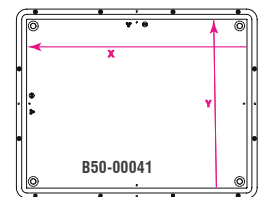

VAKUUM WECHSELSYSTEM

WK4

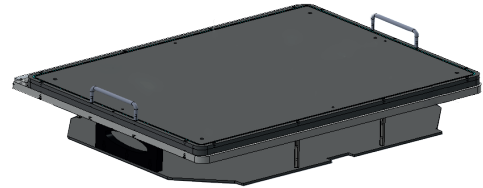
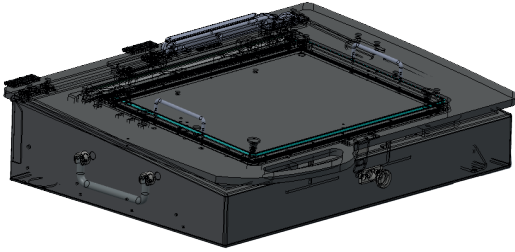

Standard

Bestellnummer	Bezeichnung
100406	WK3 Wechselkassette für 1303 Übergabekontakte

Das Vakuum Wechselsystem von ATX ist Testsystem unabhängig und kann daher auf alle Systeme angepasst werden.

- Aeroflex
- Seica
- Teradyne
- Digitaltest
- Pylon-Block

Interfacekontakte Grundgerät



Hülse 100mil 5mm
H502WW

Bestellnummer

681002



Pin Waffel 100mil
F562 06B 190 G 100

Bestellnummer

630001

Interfacekontakte Wechselkassette



Interfacepin plan WW
I-G1S1

Bestellnummer

670001

Bausatz Wechselkassette

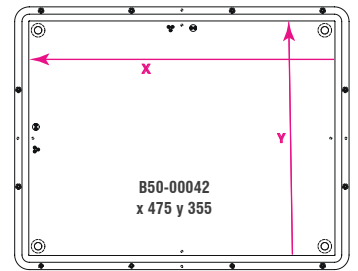

Ausbau auf Digitaltest

Bestellnummer	Bezeichnung
262350	IF-MTS-300 Interface unbestückt MTS300 Znr. E07-00139

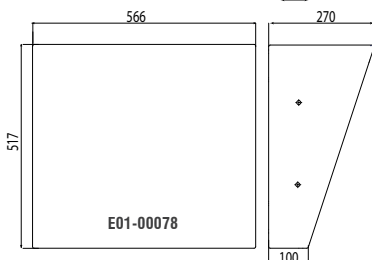
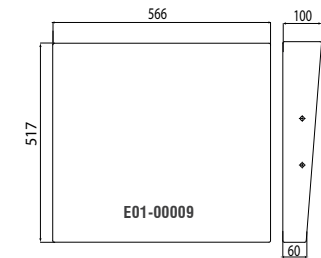

Bestellnummer	Bezeichnung
106033	KIT-V-3-Digitaltest-WK4-MTS300 Grundgerät WK4 ohne Wechselkassette WK3 Gehäuse E01-00009 Bausatz WK3 x 475 y 335 - B50-00042
106034	KIT-V-3-Digitaltest-WK4-MTS300-hoch Grundgerät WK4 ohne Wechselkassette WK3 Hohes Gehäuse E01-00078 Bausatz WK3 x 475 y 335 - B50-00042

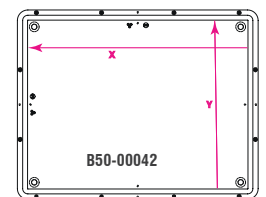

VAKUUM WECHSELSYSTEM

WK4

Ausbau auf Teradyne

Bestellnummer	Bezeichnung
584003	IF-TER-GR228X-15 Interface unbestückt 15 Slot Znr. E07-00265

Bestellnummer	Bezeichnung
584004	IF-TER-GR228X-18 Interface unbestückt 18 Slot Znr. E07-00266

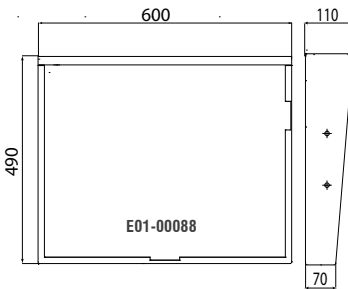

Bestellnummer	Bezeichnung
106035	KIT-V-1-Teradyne-WK4-TS12x (GR228x)-IF 15+18 Slot Grundgerät WK4 ohne Wechselkassette WK3 Gehäuse E01-00088 Bausatz WK3 x 475 y 335 - B50-00042

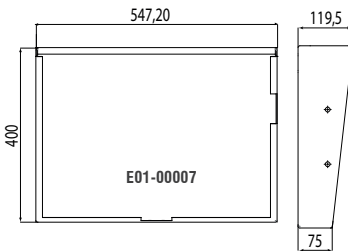
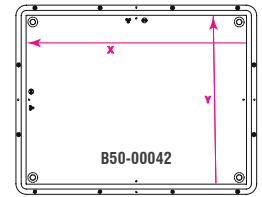

Bestellnummer	Bezeichnung
106049	KIT-V-1-Teradyne-WK4-TS12x (GR228x)-LH Grundgerät WK4 ohne Wechselkassette WK3 Gehäuse E01-00007 Bausatz WK3 x 475 y 335 - B50-00042

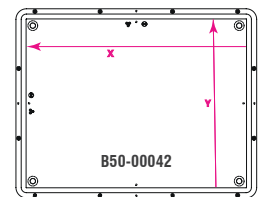

Bestellnummer	Bezeichnung
584001	IF-TER-GR228x-23 Interface unbestückt 23 Slot Znr. E07-00267

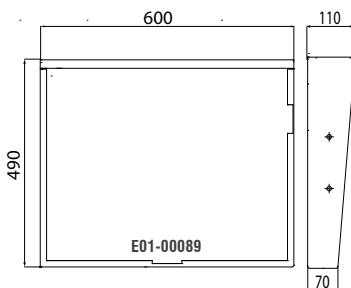

Bestellnummer	Bezeichnung
106036	KIT-V-1-Teradyne-WK4-TS12x (GR228x)-IF 23Slot Grundgerät WK4 ohne Wechselkassette WK3 Gehäuse E01-00089 Bausatz WK3 x 475 y 335 - B50-00042

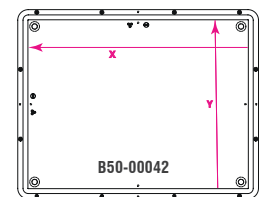

VAKUUMHAUBE

EINSEITIGE HAUBE | STANDARD

Die ATX Vakuumhauben werden mit den patentrechtlich geschützten Präzisionslagern geliefert. Durch das gefederte Ablaufelement können die Hauben besonders gut ausbalanciert werden und sind dadurch äußerst benutzerfreundlich und leicht zu bedienen. Die Präzisionslager gewährleisten eine sichere Position der Niederhalter auch bei eng bestückten Baugruppen. Niederhalter, Leiterplattenauflagen, Fangstifte und sonstiges Zubehör finden Sie in unserem [Katalog für Adapterzubehör](#).

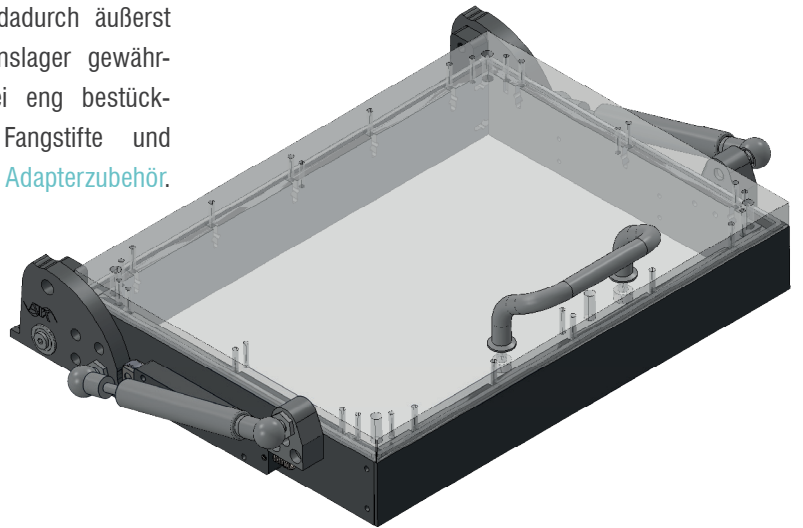

Außen- und Innenabmaß

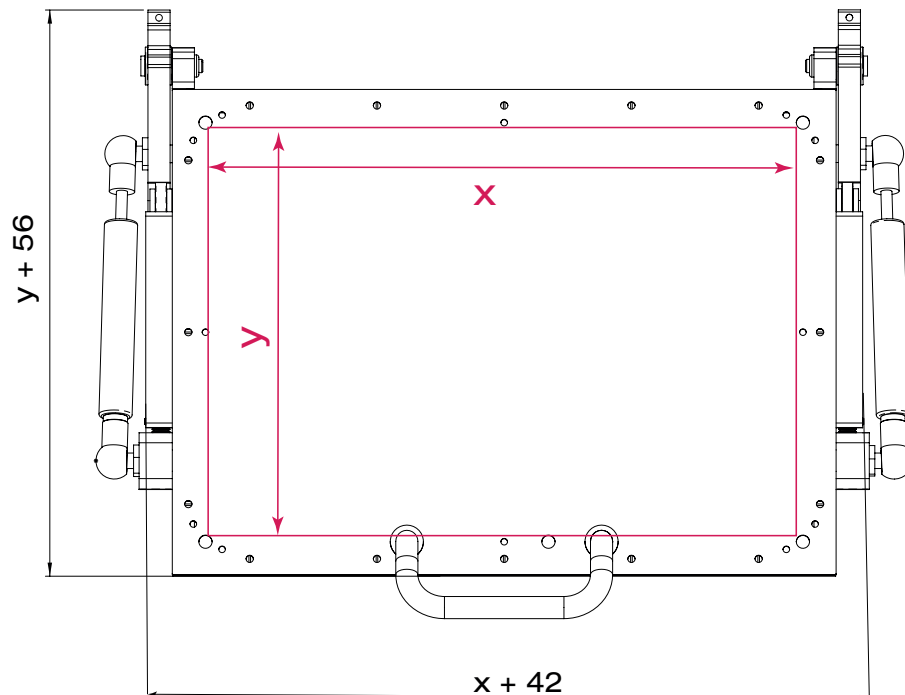

Höhenmaß

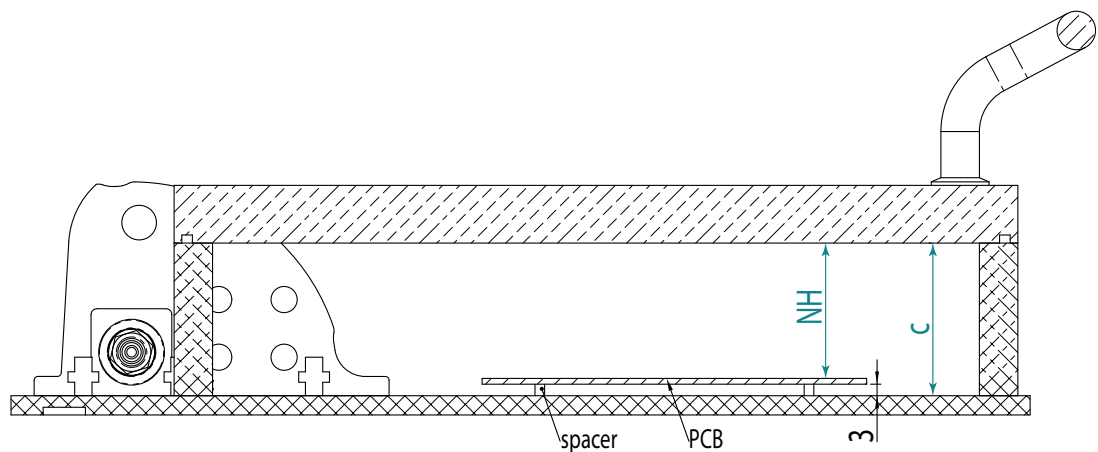

VAKUUMHAUBE

BEIDSEITIGE HAUBE | TOP ACCESS

Aufbau der Haube

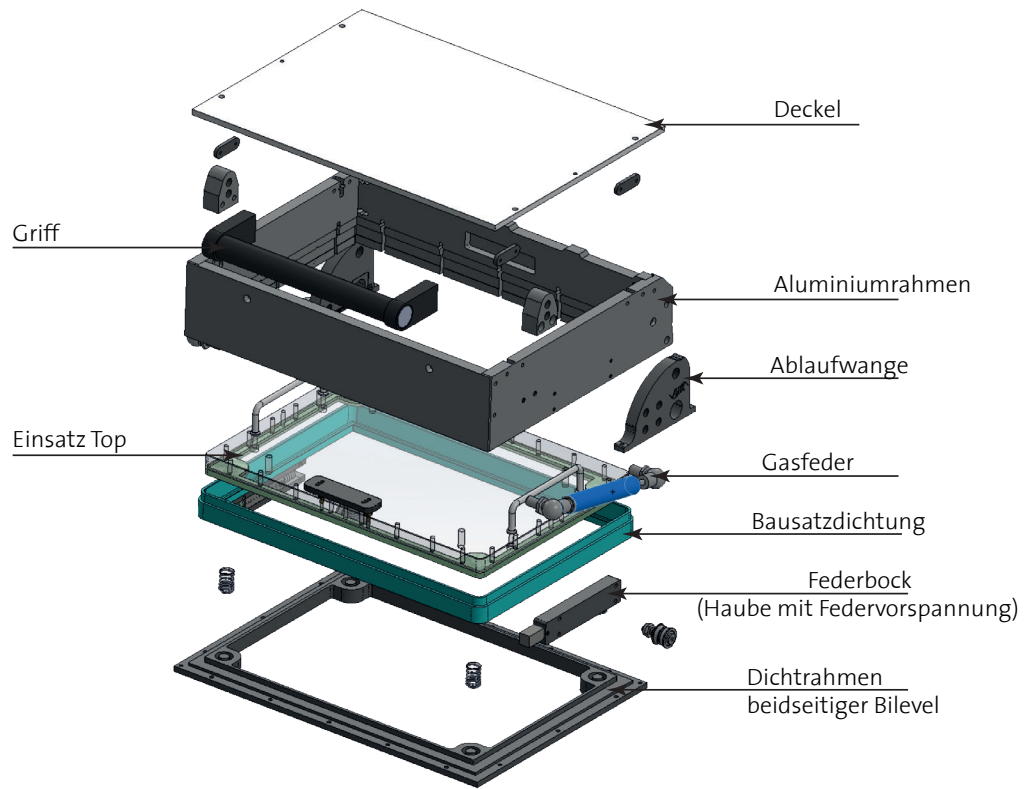

Außen- und Innenabmaß

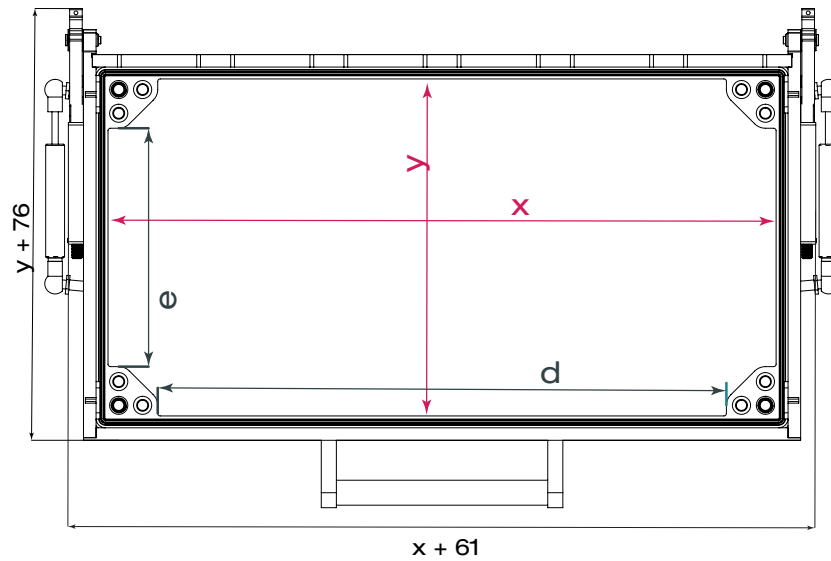

Höhenmaß

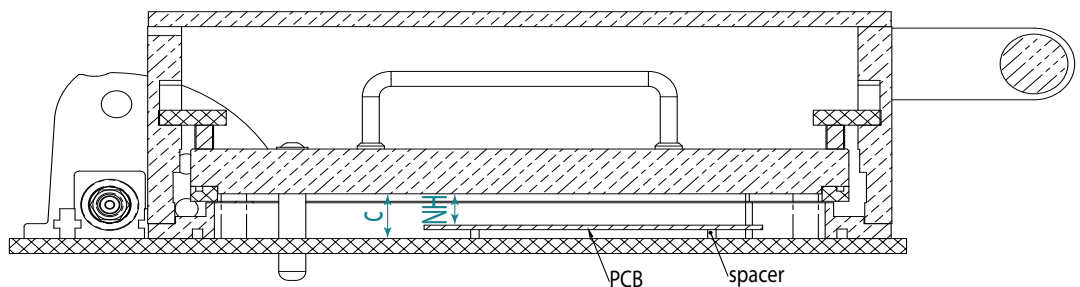



ATX HARDWARE GMBH WEST

Standort Pürgen | Am Kornfeld 8 | 86932 Pürgen

Standort Weil im Schönbuch | Carl-Zeiss-Straße 5/1 | 71093 Weil im Schönbuch

T +49 8196 9304-0

F +49 8196 9304-19

projekte@atx-hardware.de

www.atx-hardware.de